

CAT

*magazine
for the
breeder/exhibitor*

WORLD



July - August, 1973



Gives You More!

TO OUR MEMBER CLUBS—

- FREE All-American Scoring—All Fees for AA Scoring will be Paid by CFA!
- FREE CFA National Scoring.
- FREE CFA Publications: *The CFA Quarterly*, *CFA Show Manual*, *CFA Clerking Manual*.

TO OUR REGISTERING BREEDERS—

- Fast, Efficient, Computerized Service.
- Contemporary Registration Rules.
- The Protection of Litter Registration.
- The Prestige of Being a Part of the World's Largest Feline Registry.

TO OUR EXHIBITORS—

- AA Scoring—Regional and National.
- CFA Scoring—National and Regional Sponsored.
- Award-Winning CFA Cats are featured in *CATS* Magazine and the CFA Yearbook at *No Cost* to Owner.
- Award-Winning CFA Cats Receive Substantial Cash Awards as well as Engraved Plaques and Certificates.



**BIG ENOUGH TO GIVE
THE MOST!**

THE CAT FANCIERS' ASSOCIATION, INC.

P.O. Box 430

RED BANK, NEW JERSEY 07701

Editors' Preamble

SID & PAULINE THOMPSON

COVER CAT

GR.CH. GLENDOWER'S LLEWELLYN MICHAEL, our cover cat, is fulfilling a dual role by spotlighting the Isle of Man on our spinning globe and introducing the presentation of 1973 C.F.A. National Award Winners on page 20.

Owned and bred by Mrs. Margaret Thompson Los Gatos, California, *LLEWELLYN MICHAEL* is C.F.A.'s 1973 Best Red Mackerel Tabby Manx.

Sired by *GR.CH. GLENDOWER'S BRUCE*, he won this accolade for the first time in 1972 at the end of his first show season. His dam is *GR.CH. TRA MAR PAINTED LADY*.

In six shows, *LLEWELLYN MICHAEL* went Best Cat twelve times. This striking male is now 2 years old and, according to his proud owner, is quite partial to grapes! His portrait is by B. Donlon.

GREAT CATS OF NORTH AMERICA

CAT WORLD is privileged to present in this issue the 1973 C.F.A. GRAND CHAMPIONS & NATIONAL AWARD WINNERS.

A word of sincere thanks is due to Mrs. Jean Rose, Executive Director, Cat Fanciers Association, Inc., for her invaluable help with this feature; to Dr. Rosemonde S. Peltz, C.F.A. Board Member, who researched the information on *GR.CH. EASTBURY TRIGO*; and to the owners of the 25 Grand Champions whose portraits enhance the distinguished "GALLERY OF C.F.A. GRANDS".

IMPORTING AND EXPORTING CATS

Several American readers, noting the advertisements in CAT WORLD from overseas breeders, have asked us how difficult it is to import a cat into the United States.

The answer is that in these days of reliable scheduled flight by jet-liner, it is really not much more complicated than buying a cat from a distant breeder in one's own country.

There is no quarantine for healthy cats coming into the continental U.S.A. However, there is a quarantine period for cats entering Hawaii.

A small amount of duty must be paid when a cat is imported. The present rate collected by U.S. Customs is 3½%.

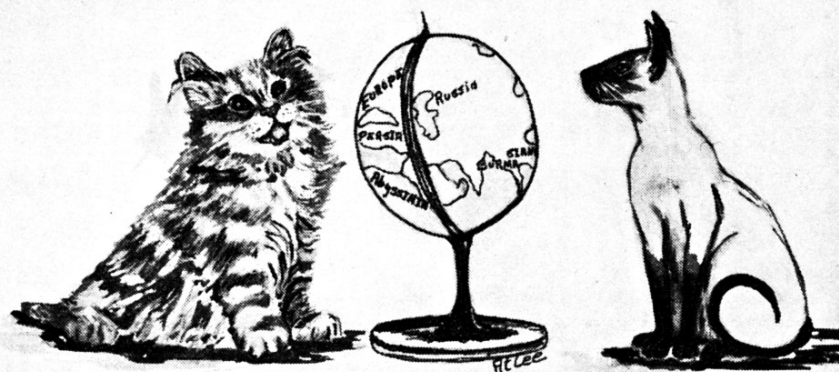

Breeders interested in importing a cat should first write to the advertiser to enquire if a suitable cat is available. One should give complete requirements, offer some information about one's cattery, and tell of the daily routine the new cat or kitten would follow in its new home. British breeders, in particular, are interested in such details as once a cat has left the U.K. it cannot return without the considerable expense of six months in quarantine.

Once a cat has been selected, arrangements for its transportation can be made by contacting the air freight department of an international airline. We ourselves have had excellent service from Pan American Airways both when importing and when exporting cats. Miss Jeanne Brafford of Pan-Am's Denver office, who arranges shipping for us, is a Siamese fancier and takes a personal interest in the welfare of cats in transit.

When one considers the long distance the cat is travelling to the U.S. from overseas, the freight costs are quite reasonable. From London to Denver, for example, an approximate distance of 3,500 miles, the cost averages about \$35 depending on size and weight of kennel.

Overseas breeders are sometimes interested in exchanging cats with breeders in the U.S. and Canada. This is an interesting avenue to explore as it reduces the cost and offers each of the parties a chance for good outcrosses.

A word of caution in choosing your import. Be sure that the pedigree meets the breed requirements of the association(s) in which you intend to register your new cat.

SHIPPING KENNELS

We recently purchased one of the Vari-Kennels advertised on the back cover of this issue and were very pleased with it.

The carrier is carefully constructed, sturdy and attractive. It's just right for shipping by air or when travelling by car and the cats seem to like it. The Vari-Kennel is bolted together in two sections which can be unbolted and used as cat beds.

(CONTINUED ON PAGE 37)

RAMSU REX

WE ARE LOOKING FORWARD TO BREEDING SOME FINE CORNISH REX DURING THE YEAR.

ALL ENQUIRIES TO:

MALCOLM & BETTY LAUDER

31 BEVERLEY CLOSE, RAINHAM, GILLINGHAM, KENT ME8 9HG, ENGLAND

65-DAY KITTEN BIRTH CALCULATOR

Tabulation was made with date of mating being regarded as day zero and date of birth expected to be 65 days later. Locate the date of mating and move along that same line to the next number printed in the same type. The date indicated is 65 days after mating (i.e. Mating on May 4, kittens due July 8; mating on July 28, kittens due October 1.)

JAN.	FEB.	MARCH	APRIL	MAY	JUNE	JULY	AUG.	SEPT.	OCT.	NOV.	DEC.	JAN.	FEB.
1	1	7	7	11	11	15	15	18	19	22	23	26	26
2	2	8	8	12	12	16	16	19	20	23	24	27	27
3	3	9	9	13	13	17	17	20	21	24	25	28	28
4	4	10	10	14	14	18	18	21	22	25	26	29	
5	5	11	11	15	15	19	19	22	23	26	27	30	
6	6	12	12	16	16	20	20	23	24	27	28	31	
7	7	13	13	17	17	21	21	24	25	28	29		1
8	8	14	14	18	18	22	22	25	26	29	30		2
9	9	15	15	19	19	23	23	26	27	30	31		3
10	10	16	16	20	20	24	24	27	28		1	1	4
11	11	17	17	21	21	25	25	28	29		2	2	5
12	12	18	18	22	22	26	26	29	30		3	3	6
13	13	19	19	23	23	27	27	30	31		4	4	7
14	14	20	20	24	24	28	28		1	1	5	5	8
15	15	21	21	25	25	29	29		2	2	6	6	9
16	16	22	22	26	26	30	30		3	3	7	7	10
17	17	23	23	27	27	31	31		4	4	8	8	11
18	18	24	24	28	28		1	1	5	5	9	9	12
19	19	25	25	29	29		2	2	6	6	10	10	13
20	20	26	26	30	30		3	3	7	7	11	11	14
21	21	27	27	31		1	4	4	8	8	12	12	15
22	22	28	28		1	2	5	5	9	9	13	13	16
23	23	29	29		2	3	6	6	10	10	14	14	17
24	24	30	30		3	4	7	7	11	11	15	15	18
25	25	31		1	4	5	8	8	12	12	16	16	19
26	26		1	2	5	6	9	9	13	13	17	17	20
27	27		2	3	6	7	10	10	14	14	18	18	21
28	28		3	4	7	8	11	11	15	15	19	19	22
29		1	4	5	8	9	12	12	16	16	20	20	23
30		2	5	6	9	10	13	13	17	17	21	21	24
31		3	6	7	10	11	14	14	18	18	22	22	25
		4		8		12		15		19		23	
		5		9		13		16		20		24	
		6		10		14		17		21		25	

CFA

Tammerisk Siamese

ACFA

*LILAC PT. *CHOCOLATE PT. *BLUE PT. *SEAL PT.
BREEDERS - SHOW TYPE

We use only the best lines---SHARA, NEW MOON, KALYAN, CATANA, CYRECCIA and MEITUI. Five litters are due in June from our top males and females. All cats have been show winners before they are used in our breeding program.

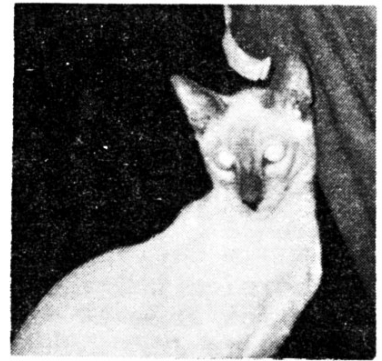

WE NOW HAVE THREE CHOCOLATE PT. & TWO LILAC PT. KITTENS FOR SALE. (MALES AND FEMALES OF EACH COLOR).

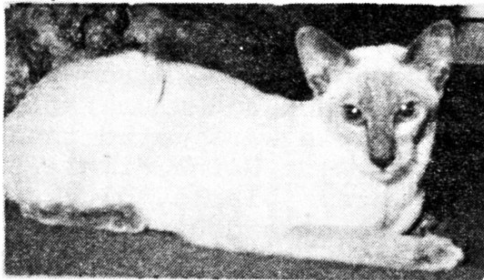

We are happy to announce that TAMMERISK CATTERY will be the new home of GR.CH. CATANA SUNDOWNER this fall. He's a Lilac Pt. male, at stud to approved queens only. Also at stud is SHARA SHADOWFAX, Lilac Pt., double bred male (picture above). His double grandsire is DBL. GRAND CH. PURRQUIST ABELARD, Lilac Pt., X double granddam is DBL. GRAND CH. CATANA FROSTORIA, Lilac Pt.

CH. LITTLE MASKS SANDAL OF TAMMERISK, LP female, bred to Shadowfax & due in June.

CAROL AND ROBERT FIEGE, JR.
91½ NO. MAIN STREET
Fort Atkinson, Wisconsin 53538

FANFAIR

OFFERS KITTENS IN
FABULOUS SILVER TABBIES

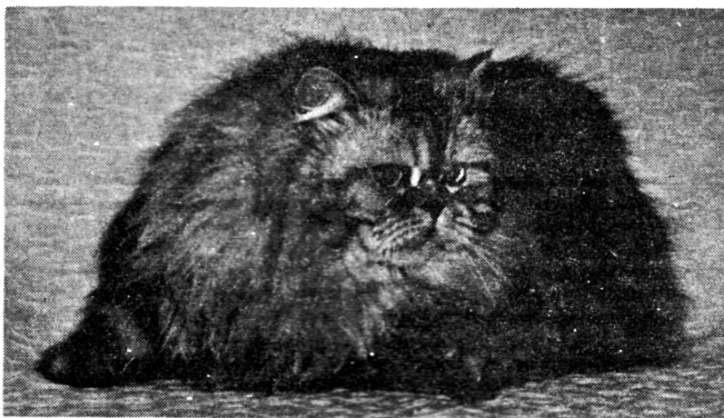

YOUR PETS STORM CLOUD OF FANFAIR

ALSO BLACKS AND RELATED COLOURS

LAIRD LEMIRE 4483 BARKER AVE.
BURNABY 1, BRITISH COLUMBIA, CANADA

ANGLO-TEX

CORNISH REX (GENE I) _____
DEVON REX (GENE II) _____
SIAMESE _____
BRITISH SHORTHAIRES _____

CORNISH & DEVON REX KITTENS
NOW AVAILABLE

** STUD SERVICE TO APPROVED QUEENS **

ATTENTION ALL CAT FANCIERS:

We would like to hear from anyone who would be interested in working with us on a DEVON REX BREEDING PROGRAM.

R.A.E. WHITE & FAMILY
4909 TOMAHAWK TRAIL, AUSTIN, TEXAS 78745
(512) 444-7346

The Blue-Eyed White

Who Is A Himalayan

BY MEVR. H. PROSÉ-IMBERT

The foreign white Shorthairs are well-known, but few know of the existence of a blue-eyed white Longhair which is bred in a similar way as the foreign white. The Himalayan is used as an outcross about the same way as the Siamese bred with the white Shorthair.

For us in Holland, this cat is not from a particular breed. It is a blue-eyed white Longhair and competes on the show bench with the other blue-eyed whites. In Europe a cat is judged on his phenotype (outerly appearance), never on his genotype (pedigree).

This nice variety began with the breeding of the first Himalayans in Holland. In Europe the Himalayan is not a separate breed but is one of the colors of the Longhairs or Persians just as Mr. Stirling-Webb, founder of the breed, wished that it would be: a Persian with the coloring of the Siamese. At this time, the beginning of the 'sixties, the Himalayans were few and did not have the type we were striving for so we had to outcross with the best Persians we could find. It was then that we got the idea of outcrossing with blue-eyed white Persians, hoping that this eye color would be less prejudicial for the eyes of the Himalayans than the usual outcross with a blue or black Persian with their copper eyes.

As there were very few blue-eyed whites at this time in Europe, and, moreover, they were deaf, two blue-eyed males were imported from America: first, *GALLAHAD'S WHITE SILK*,

and, some years later, *GALLAHAD'S TRADITION* both splendid, strong males with good blue eyes and sound hearing.

1. As the Gallahad males had the blue factor, the first matings with Seal Point or Blue Point Himalayans gave, as expected, the following kittens: blacks, blues, whites. The whites were copper-eyed, blue-eyed and odd-eyed with black and blue factor.
2. These blue-eyed whites were mated then with Seal Point or Blue Point Himalayans and the kittens were: blacks, blues, Himalayans (Seal Point and Blue Point), and whites. These whites were of two kinds:
 - (a) the ones born with a headspot* between the ears (blue or black spot) were the whites with blue or black factor, and the "points" factor in addition. They were copper-eyed or odd-eyed.
 - (b) the ones born without headspot. They were the true Himalayans under a white coat and their eyes were blue.
3. These last blue-eyed whites were mated together and the kittens were: only Himalayans and blue-eyed whites without headspot

(*Most whites are born with a colored spot or some colored hairs on the top of the head which disappear before the kitten attains adulthood. It is only the colored factor of the white cat

	Int.Ch. Adonis			
	v.d. Rombachs-			
<u>Frimousse</u>	(burg (German)	Akelei		Int.Ch.
<u>van</u>	(BP Himalayan	(Dutch line)		Gallahad's
<u>Hoog-</u>	(SP Himalayan		White Silk
<u>Moersbergen,</u>	(with chocolate		((U.S. imp.)
<u>born August,</u>	(Haradwaith	(and blue		(BE white with
<u>1972</u>	(Deidre	(dilution		(blue factor
BE white	(BE white	((BE white with SP
with SP fac-	with Ch.P	(Querida van		factor, black &
tor & all	factor & li-	(Hoog-Moersbergen		(dilution
dilutions	lac dilution	BE white with BP		(
		factor & lilac		(
		dilution		(
				(Int. Ch. Lieske
				van Haemstede
				(Dutch line)
				LP Himalayan

AN EXAMPLE OF THE AUTHOR'S BREEDING.

showing through the white coat.)

The advantage of these white kittens is that they were true Himalayans in genotype and, therefore, of sound hearing. Besides, we got a higher percentage of blue eyed whites than in the classic outcross with blues.

CHART

BE white LH X Himalayan

BE white LH (carrying "points", X Himalayan blue & black)

BE white (points carrier) X BE white (points carrier)

Pure BE whites (without factors)
BE whites (Himalayan factor)
Himalayans

It is possible that the purists will raise their hands in horror about these blue-eyed whites who are not breeding true. You see in the chart that their littermates are sometimes pure, then breeding true, but such cat is irrevocably deaf. It is why, from the first days, this last sport in the chart: BE white + BE white has been converted in: BE white + Himalayan = BE white + Himalayan (ad infinitum).

Some breeders are very proud of their pure blue-eyed whites. After generations of breeding blue-eyed whites with blue-eyed whites, they got indeed pure whites. If mated with a colored cat they get only white kittens ... who are deaf. Thank you for me! All my breeding time I have been careful

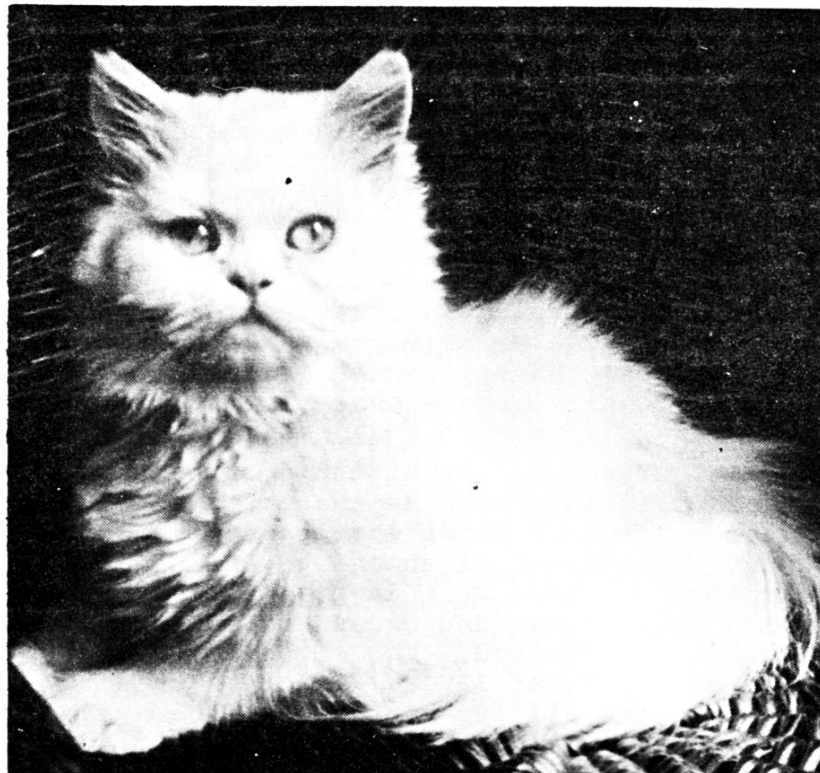

FRIMOUSSE VAN HOOG-MOERSBERGEN

Kittyville Cattery

CFA #3636

49881 JOY ROAD, PLYMOUTH, MICH. 48170

PHONE: area 313 453 3282 Appt. please

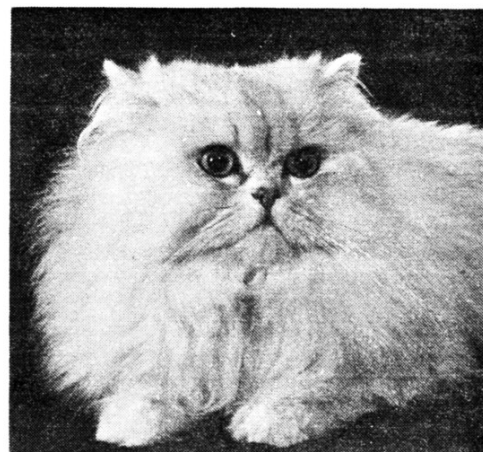

CHINCHILLA
KITTENS BORN
3-24-73.

Sire,

INTERNATIONAL
GRAND CHAMPION
JUBILEE'S
BEAUREGARD X
KITTYVILLE'S
TINSEL,
extremely typy
dam.

OTHER CHAMPION
SIRE LITTERS
AVAILABLE.

Most solid
colors, Silvers
& Himalayans.

never to mate white with white to avoid deafness. It is, on the whole, so difficult to be sure that our kittens are sold to a good home and, for the deaf ones, it is almost impossible. How can one be sure that people will give them all the care and devotion they need all their life?

As we have different Himalayan lines, there are outcrosses enough, but the white is coming from the first Gallahad imports. Considering that a white cat is a colored cat with a white suit concealing his true color, there are at the moment in Holland blue-eyed whites carrying the factor for Seal Point, Blue Point, Chocolate Point, Lilac Point, Tortie Point and Red Point.

The type of these whites is generally good, body and coat, too. The eyes are not always the deep blue that we would wish for as the Himalayans do not yet have the deep blue eyes of the Siamese, but we are steadily working toward this goal.

FRIMOUSSE, being still a kitten, has not yet been mated to test her factors. As she was, of course, born without headspot we can, at the moment, only guess as to her exact genotype. Most probably she is a Seal Point with dilutions, but she can be a Blue Point with lilac dilution, too. She is not a Chocolate Point nor a Lilac Point as her father does not carry it

We are not intending to breed pure whites, only a blue-eyed white according to the standard of the blue-eyed white Persian with the possibility of breeding from it Himalayans according to the Himalayan standard.

And, please, don't call our blue-eyed white a "White" Himalayan. A Himalayan cannot be white by definition as the "points" are its trademark. Our little blue-eyed white is just another white Persian, but with another factor than what the Fancy, until now was used to. ###

THE PURRING CREATURE THAT WALKS ON ITS TOES

BY PATRICIA TURNER

PART III - THE SKIN

The cat is a carnivore with a capital C --in fact he is the most carnivorous of all the carnivores, equipped for stabbing, biting, slicing and tearing his prey. He is a complete individualist, agile, able to run over long distances, adept at stalking, a great climber and able to make sudden jumps on creatures he fancies for dinner.

In common with all living things the cat is made up of millions of cells and, in fact, the cells can be described as units of life. The cells making up the cat's body are so small that they cannot be seen with the naked eye but they can be seen under the microscope. Although it takes millions of cells to make up the cat's body and the work of the cells is co-ordinated, each cell is really a self-sufficient unit, and as experiments in tissue culture have demonstrated, the independence of individual cells can always be regained. Cat is made up of many cells specialised to perform its various functions and it is clear that if there are enough cells in the cat's body for groups of cells to have a special function then the structure of the cells can be adapted to perform particular functions more efficiently.

As a general rule a growing cell either stops growing or divides into two immediately it reaches a certain size. Although in the simpler forms of life the two daughter cells then separate to form new individuals, the two daughter cells remain as two cells within the SAME animal body in multi-cellular animals such as the cat. It is generally agreed that the multi-cellular state of organisation is linked with the increase in size and complexity of animals above a particular level of development.

In a highly differentiated animal such as the cat, cells are specialised to carry out a restricted range of the total activities. The muscle cells are contractile units but do not conduct electrical impulses, the nerve cells conduct electrical impulses but do not contract and so on. Increased differentiation of cells in the cat's body has led to greater efficiency and cells which are similarly differentiated for a function are grouped together into "communities" called tissues. There are four main types of tissue:

(a) Epithelial tissues in which the cells are generally arranged in sheets for covering the surfaces of the body. Glands are derived from epithelial tissue.

(b) Muscular tissue in which the cells are of three main varieties but are all specialized for contraction.

(c) Nervous tissue in which the cells specialize in conduction of impulses.

(d) Connective tissue in which there are several types of cell plus an intercellular substance. This tissue includes blood cells, cartilage, bone cells and the true connective tissue cells and their products.

Structures like the cat's heart, liver and kidney are called "organs" and are complicated structures made up of several tissues combined so that they can co-operatively perform the duties essential for the life and well being of the cat. An earlier paragraph has described the fact that the cat's body is split into millions of cells each specialized to carry out a particular function and it has been explained that the cells are grouped into functional units called tissues. One of the organs of the cat is its skin. The skin is an extremely active organ and consists of several different tissues integrated to carry out the skin's functions. Cat's skin is made up of two fundamental layers of tissue with the outer layer known as the epidermis and the lower layer known as the dermis layer. The epidermis is a thick layer of cells able to counteract stresses and in parts of the body which are subjected to much trauma (or damage) the epidermis is thicker and harder than in others. A hard horny substance called keratin is produced. This thicker, harder epidermis is seen on the pads of the feet.

The cat's skin, made up of epidermis and dermis, arises in the kitten embryo from a layer of tissue known as the ectoderm. The diagram (fig. 1) shows a transverse section through the trunk of an embryo and demonstrates the three main layers of tissue from which the tissues and organs of the kitten and cat are derived. The ectoderm is clearly seen as the outer layer. It gives rise to the skin and all its structures, the nervous system and to a part of the fore and hind gut. Once the skin has developed from the ectoderm it becomes a self maintaining, self regulat-

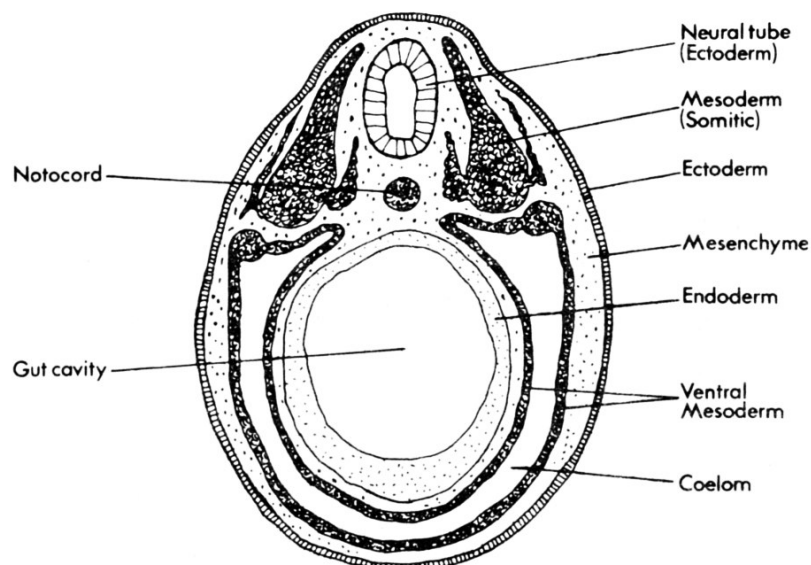

Figure 1:

A transverse section through the trunk of an embryo. The three germ layers, endoderm, ectoderm and mesoderm, are all illustrated. The packing tissue between the three layers is made up of a loose undifferentiated tissue which is called mesenchyme. Mesenchyme is derived by migration of cells from the mesoderm. From it arise the various connective tissues of the kitten and cat, including blood vessels, bone cartilage, tendon, ligament, etc.

Illustration by Malcolm Lauder

ing organ. The lowest layer of the epidermis (seen in Fig. 2 and known as "the Malpighian layer") is constantly dividing in a plane parallel to the skin's surface so that new layers of cells are always appearing to replace those rubbed off the outside. As the cells produced by the Malpighian layer get older and nearer the surface they die and become flattened. The flattened dead cells are made of a protein called keratin, the material from which claws are made. This outer layer of the cat's skin is often called the stratum corneum or "the horny layer". Underneath the epidermis is the dermis, a layer made up of connective tissue in which there is a large amount of intercellular substance in relation to the number of cells present. Many tissues go to make up the dermis including nervous tissue, muscle tissue and connective tissue. The dermis contains the sebaceous glands, the blood vessels, the hair follicles, muscles and nerve endings.

Like all the cat's organs, its skin is responsible for carrying out a number of things on behalf of the whole body. Some of these functions are listed:

- (a) It protects the cat's body;
- (b) It receives stimuli;
- (c) It regulates temperature;
- (d) It provides milk for kittens;
- (e) It conserves water;
- (f) It produces claws, whiskers, eyelashes and fur.

BADI CATTERY

HIMALAYANS EXCLUSIVELY

Proudly Presents 1972-1973
ALL-SOUTHERN & CFA GULF SHORE REGIONAL
HIGHEST SCORING HIMALAYAN & LONGHAIR CAT

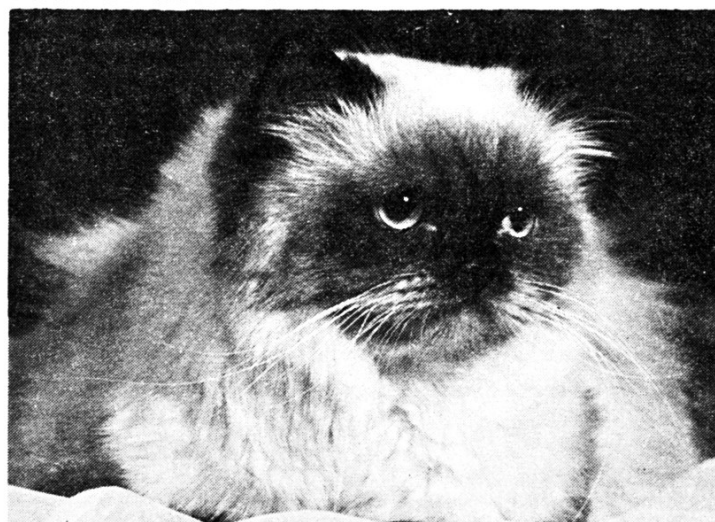

HO-CO-MO ATLANTA OF BADI
(daughter & grand-daughter of
MINGCHIU MURDOCK OF BADI)

BEST ALL-SOUTHERN LONGHAIR CAT
4TH BEST ALL-SOUTHERN CAT
BEST ALL-SOUTHERN HIMALAYAN & SEALPOINT
CFA GSR BEST HIMALAYAN FEMALE
2ND BEST HIMALAYAN & 2ND BEST SEALPOINT

AND:

BADI CRUSADER CHIN
CFA GSR BEST HIMALAYAN
BEST MALE AND BEST SEALPOINT
--STUD SERVICE BY MURDOCK & HIS SONS--
BY RESERVATION.

KITTENS IN SEAL, BLUE, LILAC &
CHOCOLATE POINTS.

HEIDI NODDIN 105 YOUNG BLVD.
UNIVERSAL CITY, TEXAS 78148 U.S.A.

PROTECTION OF THE CAT'S BODY

The cat's skin stretches over the whole surface of its body and it also continues into several of the body orifices. When its surface is intact the only places where germs can penetrate it are the hair follicles (pores) and the sweat ducts. (There are, of course, other means of entry through apertures of the urinary, genital, alimentary and respiratory tracts). If "invaders" DO get in through the epidermis, the connective tissue in the dermis forms a very efficient second line of defence and the process of inflammation develops. This combats the infection. Fuller details of this will be given in a forthcoming article.

Protection against harmful effects of solar radiation is provided by pigment cells lying just below the Malpighian layer. White cats, with skin lacking pigment, also lack this protection and this is the reason for the "sunburn" often seen on the skin in front of the ear and on the tips of the ear when

they are subjected to prolonged sunlight. In the wild state, cats (the wild type tabby cat) are also protected by the "cryptic" colouration of the pigmented hair allowing them to look like their normal background.

RECEPTION OF STIMULI

The whole of the cat's body is covered by receptive spots for touch, heat, cold and pain and, at any one time, thousands of receptive spots are being stimulated. It is from the general pattern of these stimulation fields that the cat's central nervous system allows the whole organism to be aware of the changing conditions around it. Certain areas of the skin are more sensitive to stimuli than others and it appears that skin that is hairless, such as on the lips, has a more highly organized sense receptor system than does hairy skin such as on the trunk. It is thought that any particular nerve fibre can respond to only one kind of stimulus, special nerve pathways for temperature, pressure, pain and touch information. Unfortunately, it is not possible to identify the function of individual nerves by the structure of the receptor as nerves with differing functions may start at what appear to be identically structured receptors. The nerves, which start as receptors, are situated in the dermis of the cat and can be seen in the diagram (Fig. 2). If only as a means to convey information to the cat's central nervous system the cat's skin is very important in adapting the cat's body to its surroundings.

REGULATION OF TEMPERATURE

This third function of the skin is found only in birds and mammals--animals described as homiothermic. Other animals are called poikilotherms. Homiothermic animals, such as the cat, can adapt to live in the tropics or the arctic or to function efficiently in the heat of mid-day or the cool of midnight. Poikilotherms may be either too hot or too cold to even move under these conditions. Although some homiothermic animals hibernate when conditions are really cold, the majority, including the cat, live an active life throughout the year. The ability to regulate temperature has enabled the cat to extend its

Figure 2:

Diagram of the structure of mammalian skin. The cat has no sweat glands but is otherwise similar.

Illustration by Malcolm Lauder

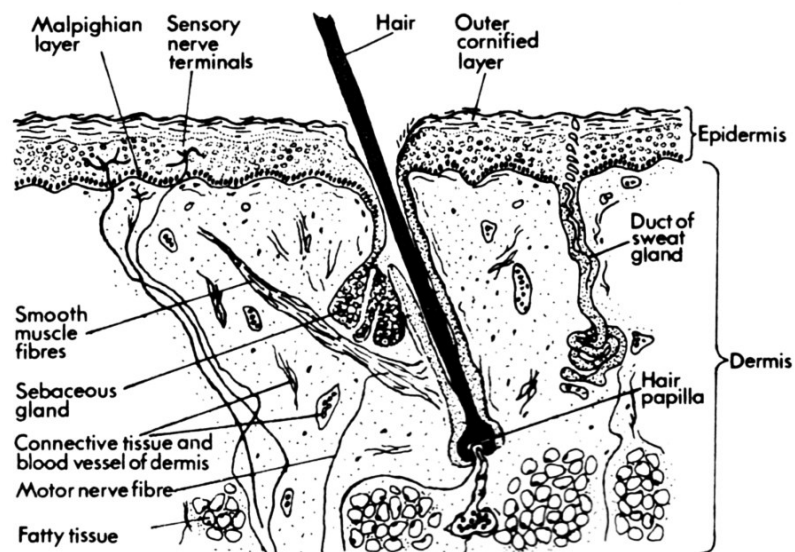

range of activities much further than the reptiles could ever have gone and the evolution of this ability was essential before living in air was fully mastered by animals. The range of temperatures encountered when living in air is much greater than that of living in water and the speed at which changes occur is more rapid. The development of this ability meant that the early mammal ancestors of the cat could move away from places that were overcrowded with competitors and that they could feed at night when the temperature would be unsuitable for poikilotherms.

The constant internal temperature is also a very great advantage in the complex animal that is the cat, for chemical reactions can proceed at a much more constant speed than would be possible in a temperature that fluctuated.

The cat's skin is very important in temperature regulation because its large surface is a potential site for heat loss. So the first requirements of the skin of the cat is that it should be a good heat insulator.

OUT OF THE PHOTO ALBUM ...

PAINTINGS AND DRAWINGS

BY

Atlee

2565 S. HIGH
DENVER, COLO. 80210
Tel: 778-1401

... AND ONTO THE WALL

FORCED TO MOVE!

MUST REDUCE STOCK IMMEDIATELY

SIAMESE--COLORPOINTS--HIMALAYANS

- *CHOCOLATE POINT SIAMESE STUD, son of All-Star Gr.Ch. *Thaibok's Ruby Foo* X Dbl. Gr.Ch. *Catana Frostoria*, proven, extremely reasonable.
- *PERSEPOLIS SEAL LYNXPOINT STUD, proven.
- *CHARWIN/VELVETEEN REDPOINT FEMALE, 10 months.
- *KEKO/HARTLINE TORTIEPOINT FEMALE, proven, 2 years.
- *SAMARKAND TORTIEPOINT HIMALAYAN FEMALE, 2 years, AA parents, proven.

OTHER TOP BREEDERS AND KITTENS:
LYNX, RED, TORTIE
PLUS TRADITIONAL COLOR CFA SIAMESE.

HARR/BOWA
 CATTERIES
 201-731-4311

Barbara J. Harr
 109 Ashland Avenue
 West Orange, N.J. 07052

The layer of fat beneath the skin and the fur fulfils this requirement. The cat's fur is of importance because air is trapped beneath it.

Another very important fact governing the amount of heat lost is that the amount of heat supplied to the skin can be varied by altering the diameter of the blood vessels in the skin. If the smooth muscles in the walls of the arterioles contract a reduced quantity of blood and heat is present in the cat's skin. So, in cold weather, the arterioles contract and the areas of the skin that can be seen will look "pale". On the other hand, when the cat's body is too hot the arterioles dilate and a greater volume of blood flows through the skin, thus losing heat from the body. Thus the amount of heat entering the skin is controlled by constriction or dilation of blood vessels whilst the subcutaneous fat and hair help by insulating the body from its environment.

All mammals lose some heat in their breath and as the cat has no true sweat glands other than on the pads of the feet it can, if necessary, lose heat by panting. It also controls heat loss by its behaviour. On cold days the cat will curl up like a ball, presenting only the smallest possible area for cooling. On hot days it will stretch out on its side with its limbs extended to expose the maximum amount of body surface. Vigorous movement generates heat within the body whereas lassitude keeps the body cool. So it

NO RUZ cattery

Turkish
 Angoras

BREEDING FOR BEAUTY

AND DISPOSITION

TAI-PHOON KAYA-ALA
OF NO RUZ

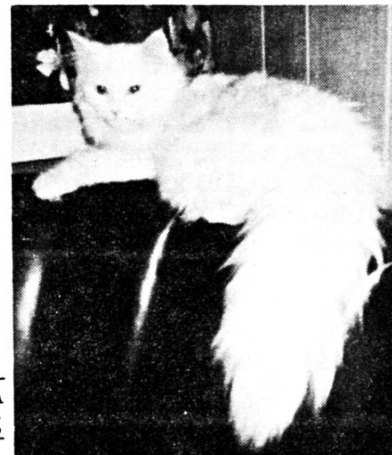

BOTH 'KAYA-ALA' AND MY GRANT MALE
 HAVE LONG, SILKY COATS AND SWEET,
 LOVING DISPOSITIONS. INQUIRIES
 FOR KITTENS ARE INVITED.

ELAINE GESEL
 5334 GENESEE STREET
 BOWMANSVILLE, N.Y. 14026

can be seen that several tissues in the skin co-operate to regulate the cat's body temperature.

CONSERVATION OF WATER

The dead cells of the stratum corneum are heavily keratinized so that they form a waterproof layer which keeps water in the cat's body. This property of its skin allows it to live in dry places. The sebaceous glands also produce a secretion which may help in waterproofing.

PRODUCTION OF MILK

The mammary glands are made up of cells resembling those of the sweat glands and are usually considered to be modified sweat glands. These glands are derived from the skin and supply milk to feed the young kittens.

PRODUCTION OF CLAWS, WHISKERS, EYELASHES, FUR

There are also other derivatives of the inner and outer layer of the cat's skin and these include the claws, whiskers, eyelashes and fur.

("THE SKIN OF THE CAT" WILL BE CONTINUED)

*Advertising Deadline
 For Next Issue: Aug. 4*

VIGGO A. MORTENSEN (DENMARK):

Due to the rapidly increasing population of stray cats in the suburban areas of Denmark and the problems attached thereto, the question arose, "How is it possible to limit the birth of kittens?"

Under veterinary surveyance, the population of stray cats was, as far as possible, localized and registered in a town of approximately 60,000 inhabitants. At various feeding places, the cats were fed with fish into which was added the product *medroxiprogesteronacetate*. This product impeded the female cat's rutting season and, within a short time, it turned out to be a success.

There have been, and still are, objections against this form of limiting the cat population. The two most important objections are: (a) the medicine must be taken regularly; if not, pregnancy might occur ending with stillborn kittens which the mother might have difficulty in bringing forth; and (b) there is no knowledge as to how this product will affect the males eating it.

This experiment was, however, the starting point for experiments with the product on cats in private homes. The amount of 2.5 mg turned out to be sufficient for impeding the rutting season, i.e. one pill per week prevents all the inconveniences connected with the rutting season.

Cats & "The Pill"

Veterinary Views From

At present we do know that the above-mentioned amount is sufficient to keep cats off season, but we do not yet know exactly how long a time it takes for them to come in season after the administration of the pill is ceased. This period varies from 14 days to 3 weeks or even longer, a fact which is of great disadvantage to people involved in breeding.

Because of the above experiences, it is our opinion---which is shared by many vets especially concerned with cats---that the most reasonable thing for a cat owner keeping a female cat as a pet is to have her sterilized and this is also beneficial to the cat itself! For those breeders who prefer to keep the female cat from rutting season for a shorter time, we can recommend the product as long as the medicine is administered regularly, under control and in the prescribed dose.

The product *medroxiprogesteronacetate* is available under different names from various medical firms. In Denmark it is *Perlutex Leo*.
(TRANSLATED FROM DANISH BY SUSANNA BUGGE)

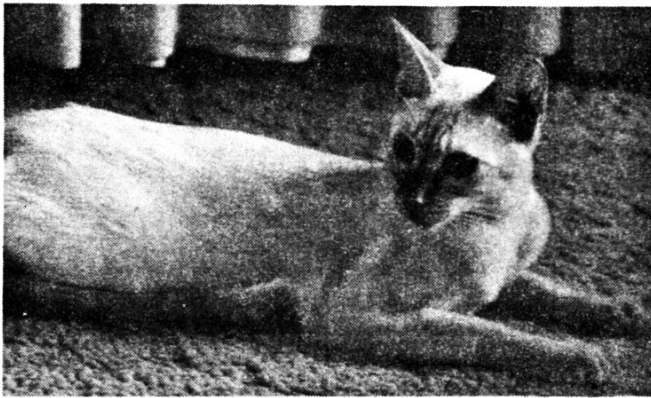
B
O
D
A
N
T
E

For Sale

RED POINT KITTENS:

2 females & 1 male, sired by BODANTE UTOPIAN. Dams--SOLITAIRE FIREOPAL (dam of SANDPIPER) and SOLITAIRE TAMARANI, both imports.

SEAL TORTIE POINT KITTEN:

Daughter of UTOPIAN & TAMARANI. Vivid eye color and markings with a very good blaze.

RED POINT YOUNG ADULT FEMALE:

Born August, 1971. Sire is litter brother of GR.CH. BODANTE MOCKING-BIRD, 1971 3rd Best AA Red Pt.

ALL KITTENS ARE C.F.A. LITTER-REGD. & ARE ELIGIBLE FOR A.C.F.A. REGN.

Congratulations to

← GRAND CH. BODANTE SANDPIPER
1973 BEST ALL-WESTERN RED POINT

CH. BODANTE UTOPIAN
1973 BEST RED POINT, N.W. REGION, C.F.A.

CH. BODANTE CAMDEN TOWN OF TIKI
1973 BEST BLACK SMOKE REX, N.W. REGION, C.F.A.
1973 2ND BEST ALL-WESTERN SH KITTEN
1973 3RD BEST ALL-WESTERN KITTEN

CH. SOLITAIRE TONGAN PRINCESS
1973 BEST HAVANA BROWN, N.W. REGION, C.F.A.

QD.CH. MANANA TWINKLE OF BODANTE
1973 BOX ALL-WESTERN BRITISH SHORTHAIR

BLACK & BLACK SMOKE REX KITTENS:

Sire: GR.CH. RODELL'S RESOLVED OF ANGLO-TEX
Dam: GR.CH. ANGLO-TEX BRITANNIA OF BODANTE
'Brit' is the dam of BODANTE CAMDEN TOWN OF TIKI and BODANTE CANTERBURY BELLE, typey
Black female who took final wins in the two CFA and one ACFA shows she has been to.

RED POINT & LYNX POINT STUD SERVICE
FROM MALES OF BRITISH PEDIGREE TO
APPROVED QUEENS.

5395 SOUTH MILLER STREET, LITTLETON, COLORADO 80123

PH: 303-986-0442

Denmark & U.S.A.

L. C. SEALING, D.V.M. (USA):

Because of the explosion in the pet population, there has been a growing interest in developing an effective, cheap and safe birth control device for animals. This would be a desirable thing for owners and exhibitors of purebred animals. The recurring estrous cycle can cause problems in the show ring such as behavioral distractions, coat appearance and mismatings.

In small animals, various progesterone compounds have been tried and used for this. During the early sixties, Promone, (made by the Upjohn Company), medroxyprogesterone acetate, was being used by veterinarians in dogs and cats. In a small percentage of animals administered to, a condition known as pyometra developed. This condition is where the uterus fills up with a toxic exudate. The animal becomes very ill and may die if not treated right away. In practically all conditions of pyometra, an ovariectomy is usually the only successful treatment. Because of this, the Federal Drug Administra-

★ Star Br't Persians

VOO DOO, SILVA WYTE, SHAWNEE
AND SIMBELAIR LINES.

CFA REG.
HEALTH GUARANTEED.

Blacks, Whites,
Bi-Colors & Solids
carrying AM. Bi Gene

Black Kittens due
in June from
DOUBLE VOO DOO CROSS

Also Solid Kittens
carrying AMERICAN Bi
Gene of TRIPLE VOO
DOO CROSS

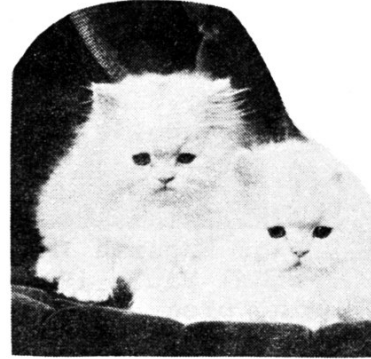

458 WEST AVE.
PITMAN, N.J. 08071
Phone: 609-589-2295

tion withdrew the drug from veterinary use. The same drug may be obtained under a human label but most veterinarians are reluctant to prescribe it because of legal and ethical considerations.

Testosterone, a male hormone, has been used to suppress the estrous cycle in greyhounds. Greyhounds are not allowed to race when in season. Various greyhound breeders with whom I have talked claim good success with very little aftereffects. To my knowledge, no one has tried this in cats.

Original Full Colour Paintings

FROM PHOTOS OR TRANSPARENCIES

BY THE WELL-KNOWN BRITISH ARTIST

Miss Julia Oswin - Palmer

LONDON EXHIBITOR

A RARE OPPORTUNITY TO OWN A VALUABLE ORIGINAL PAINTING OF YOUR FAVORITE CAT ... A BEAUTIFUL WORK OF ART THAT YOU WILL TREASURE FOREVER. MISS OSWIN-PALMER IS ALSO RENOWNED FOR HER PORTRAITS OF PEOPLE, OTHER ANIMALS, SCENIC VIEWS AND STILL LIFE.

PRICES DEPEND UPON SIZE, MEDIUM SELECTED, ETC. AN 8" x 10" PORTRAIT OF ONE CAT DONE IN PASTEL WOULD BE £15 (approx. \$39); IN ACRYLIC (similar in appearance to an oil painting but moderate in price), IT WOULD BE £25 (approx. \$65). POSTAGE & PACKING EXTRA. PLEASE WRITE FOR QUOTATION.

OIL * ACRYLIC
PASTEL * CHARCOAL



FLAT 7, THE GABLES,
28 WIMBORNE ROAD,
BOURNEMOUTH BH2 6NU, ENGLAND
TELEPHONE: BOURNEMOUTH 28901

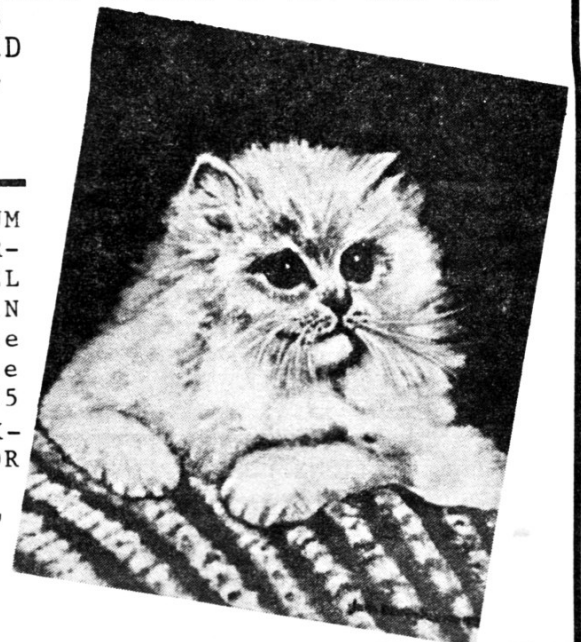



GRAND CHAMPION
Ru-Bon's Sorceress

Watch for
this lovely
sealpoint on
the 1974 Pet
Pride Stamps!

Ru-Bon Cattery

CFA - ACFA Regd.

4030 N.E. 28th AVENUE
PORTLAND, OREGON 97212

RUSS
AND
BONNIE
AMES

(503) 282-1421

We are proud to announce the following of our fine queens are due to kitten this summer: *Gr.Ch. Ru-Bon's Sorceress* (seal), *RM Qd.Ch. Phyatak Snow Flower of Ru-Bon* (lilac; received gratefully from Mrs. Pamela Logan); *Dbl.Gr.Ch. Phyatak Regencee of Eluam* (blue, soon to be ours, thanks to Andy Simpson), *Ru-Bon Scho-Litza* (chocolate), and we do presently have kittens from *Taos Sugar of Ru-Bon* (seal). These lovely females, and their mates give us the following fine bloodlines: *Fan-T-Cee, Phyatak, Medicine Lake, Dahin, DiNapoli, Jen-Kins, Catana, Maloja, Newton, Tap-Toe*, and fine English Imports. Since the death last summer of Mrs. Ethel Maule (Phyatak Cattery), we have redirected our breeding program toward the preservation of the exquisite Phyatak Siamese. Besides the Phyatak females mentioned above, we also have *Phyatak Dardenne of Ru-Bon*, mother of *Sorceress*. All of these cats are or will be bred to top males and we feel that Ru-Bon will be able to offer excellent top show quality kittens later this year. Our own lovely *Sorceress*, although now two years old and after raising six kittens, was again named Second Best Sealpoint in the Northwest Region (CFA), and is still taking top five wins consistently including Best Cat in allbreed. We are now taking reservations for kittens from these fine cats for delivery in the fall. All serious inquiries invited, pedigrees furnished on request. We also offer seal and blue stud service from top bloodlines.

Cattery Hoog- Moersbergen

SPECIALIZING IN ALL COLORS OF

Himalayans

BEAUTIFUL *Persians*, Too

KITTENS FOR SHOW AND BREEDING

MRS. PROSÉ

Gastelseweg 45. Budel (N-B) Holland

Ph: 04958-1711

FOREIGN WHITE



CAT FANCIERS ASSOCIATION

- * SPECIALIST CLUB FOR THE BEAUTIFUL, BLUE-EYED, SIAMESE TYPE SH KNOWN AS FOREIGN WHITE.
- * ALL KITTENS APPROVED FOR EXPORT BY FWCFA HOLD A SPECIAL CERTIFICATE. ARRANGEMENTS CAN BE MADE FOR JUDGES ASSESSMENT BEFORE SALES ARE COMPLETED.
- * ENQUIRIES FOR FW KITTENS TO:
JULIE FARLEY, Wilderness Cottage,
Nunhold, Hatton, Nr. Warwick,
England
- * ENQUIRIES ON FW BREEDING TO:
PAT TURNER, 7 Bodiam Crescent,
Eastbourne, BN 22 9HQ
England

GR.CH. JO BO'S
POJOAQUE OF LOS
COLORADOS, Red
Aby male owned
by Marilyn T.
Fuentes, Texas.
L. Guidry photo

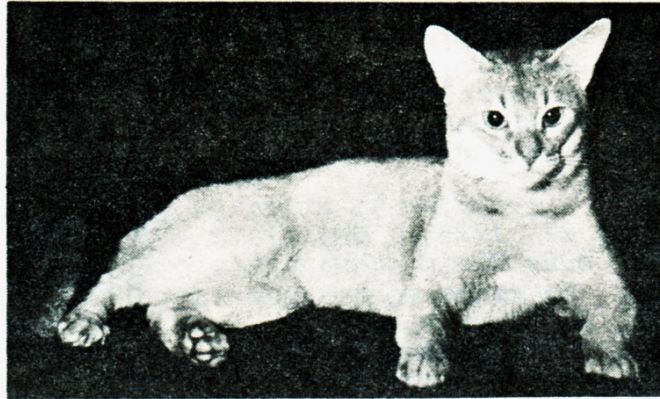

Great Cats Of N. America



GR.CH. EEE-DEE'S LITTLE
TID-BIT, Chinchilla Pers-
ian female, owned by Edith
Price, California.
Hans Bomskow photo

Gallery Of 1972-'73 C.F.A. Grand Champions



GR.CH. SMITHWAY MAXIE,
Red Tabby Persian male
owned by Mr. Leonard
Smith, California.
Jan Claire photo



GR.CH. CHIN
HILLS ROB ROY,
Cream Tabby
American
Shorthair male
owned by Jo
Ann Ford,
Florida.

Introduction

In 1930, CAT FANCIERS ASSOCIATION, largest registering body of cats in the United States of America today, instituted GRAND CHAMPIONSHIPS. Forththree years ago, the first cat to qualify for the new accolade was *EASTBURY TRIGO, IMP.*, Red Tabby Persian male.

TRIGO was born in England May 22, 1929, and was imported into the U.S. by Miss Elsie Hydon, a past president of C.F.A. Later he was owned by Mrs. John S. Hunter, Mt. Vernon, New York. He died on September 17, 1936, and was still regarded, many years later, as the finest Red Tabby ever bred in England or to compete in the U.S.

This past show season, a total of 190 cats earned the coveted status of GRAND CHAMPION by their prowess in C.F.A. shows. In addition, thirteen other cats became C.F.A. GRAND PREMIERS.

Seventeen of the nineteen breeds recognized by C.F.A. for Championship competition are represented in the list of new GRANDS which finds the females outnumbering the males 111 to 79. Only the Balinese and Havana Browns are missing.

Breed leaders this year are the Persians claiming almost half of the GRAND CHAMPIONSHIP titles with 91 cats (48 females, 43 males). Fifty of these competed in the Solid Color Division, among them 13 Blues and an equal number of Creams. Of twelve cats in the Shaded Division, 6 are Shaded Silvers and 4 Chinchilla Silvers. There are seventeen Parti-Colors, 11 of which are Blue Creams. Six of the Persians in the Tabby Division are Brown Tabbies, and there are two new GRAND CHAMPIONS in the Smoke Division.

C.F.A.'s Siamese breeders came up with 34 GRAND CHAMPIONS of whom no less than 32 are females! There are 15 Seal Points, 8 Lilac Points, 8 Blue Points and 3 Chocolate Points.

In third place are the Burmese with seventeen new GRAND CHAMPIONS.

The next four places were won by the Abyssinians with eight Ruddy and two Red cats; American Shorthairs and Manx with nine GRANDS each; and the Russian Blues with seven males and one lone female.

Five Exotic Shorthairs and three Rex made the honor roll which is completed by one GRAND CHAMPION from each of the Birman, Colorpoint Shorthair, Himalayan and Korat breeds.

Of the thirteen GRAND PREMIERS, five are Burmese females, four are Persians and there is one American Shorthair, an Exotic Shorthair, a Manx and a Siamese.

There was a tie for the distinction of being the cattery to produce the highest number of cats meriting a GRAND title. The following six catteries each bred three of the new GRAND CHAMPIONS:



GR.CH. CHINQUAPIN'S PUFF'N'STUFF,
Sable Burmese male owned by Mr.
Hal Smith, Florida.

CASTILIA (Persians)

Marcena Myers, Aliquippa, Pa.

KELSHA (Manx)

Judith D. K. Shaw, Woodbridge, Va.

LIN-HOW-SAN (Siamese)

Betty, Lew & Lynn Rabinowitz, Far Rockaway, N.Y.

MISTY MORNIN' (Persians)

Charles P. Milwain & Linda M. Swope, Smyrna, Ga.

OL-RAY (Persians)

Mrs. Raymond Klotz, Mineola, N.Y.

TOK-LAT (Burmese)

Joan Batchelor, Evanston, Il.

It is interesting to note that seven of the past season's new GRAND CHAMPIONS were winners of 1972 C.F.A. Kitten Awards. *WYN-DEN'S ROBIN*, Brown Tabby Persian female, was 2nd Best Kitten on a national level and Best Kitten in the Gulf Shore Region. *CATSREALM BIENQUISTA*, Black Smoke Persian female, was 5th Best Kitten nationally and 2nd Best in the Gulf Shore Region.

Other regional winners were: *TOK-LATS LITTLE AWFUL ARNIE*, Burmese male, Best Midwest Kitten; *PHAROH CITATION OF SWINGATE*, Ruddy Abyssinian male, 2nd Best Northwest Kitten; *EEE-DEE LITTLE TID-BIT*, Chinchilla Persian female, 4th Best Southwest Kitten; *ERIADOR'S PIPPIN II*, Ruddy Abyssinian male, 4th Best Midwest Kitten; and *PHI-LINE LITTLE BIG MAN*, Burmese male, who tied for 4th Best North Atlantic Kitten.

To win their GRAND CHAMPIONSHIPS, each of these cats had to accumulate 150 points (earned by defeating other Champions) and be selected as one of the Top Five cats in at least one of the shows in which he/she competed. It is not easy to win a C.F.A. GRAND CHAMPIONSHIP. Cats who succeed are really deserving of their laurels.

In this "GALLERY", the latest C.F.A. GRAND CHAMPIONS are presented by breed. Given with each cat is its color, sex and name of owner.

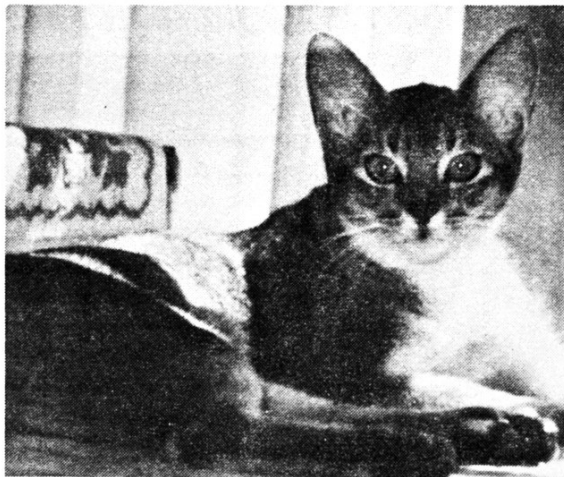

ABYSSINIAN GRAND CHAMPIONS

EL QAHIRA'S DESERET	F Ruddy	Rae Ann Christ
ERIADOR'S PIPPIN II	M Ruddy	L. & S. English
GAINES PENELOPE OF PUSSY PUR MEW	F Red	P.Klepinger & J.I. Pattons
GALLANTREE'S HOT PANTS	M Ruddy	G. & N. Poole
GENANDRA'S ALEX	M Ruddy	Michael G.Drake
JO BO'S POJOAQUE OF LOS COLORADOS	M Red	Marilyn Fuentes
PHAROH CITATION OF SWINGATE	M Ruddy	Robt. S.Everett
PURRONG'S BIR-HAN	M Ruddy	L.F. Schweitzer
QUIN-JO'S CASSANDRA	F Ruddy	M/M R.K. Jones
WOHL-RABE WARLOCK OF SCARLETT	M Ruddy	G. & N. Poole

GR.CH. EL QAHIRA'S DESERET, Ruddy Aby female owned and bred by Rae Ann Christ, Ca.

AMERICAN SH. GRAND CHAMPIONS

BRANDYWOOD TEQUILA TACAYO	M Shaded Silver	D. & J. Wood
CHIN HILLS ROB ROY	M Cream Tabby	Jo Ann Ford
DUNN'S LEO MINOR	M Brown Tabby	J.Dunn & B.& W. Negus
ESQUIRE FLIGHT OF RAVEN	F Black	R. Bradshaw & A.Fesenfeld
KAYVANA'S MAIDA	F Brn.Mk.Tabby	K. Van Allen
MR. PETER PAN OF BAMS	M Cameo Mk.Tby.	N. & A.Silvers
ROCOCO RUBY PETUNIA	F Tortie	A. Frecowski
TABB-I-VILLE TIPPECANOE	M Silver Tabby	Anita J. Harris
WAH-LE DARLIN' DOLL OF YANG-LE	F Silver Tabby	M/M G.A.LeFever



GR.CH. TABB-I-VILLE TIPPECANOE, Silver Tabby male ASH owned by Mrs. Anita Harris, Texas.

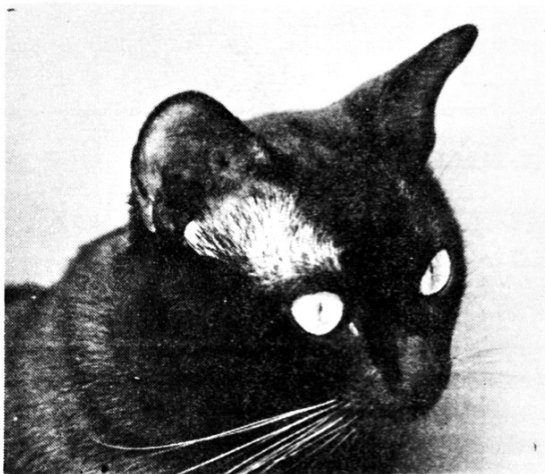

GR.CH. GINGERWOOD NIGHT-TRAIN, Sable Burmese male owned by Dr. & Mrs. H.R. Gordon, Florida.

BURMESE GRAND CHAMPIONS

AH-SEE'S FANNIE MAY	F Sable Brown	D. Torgesen
CHINQUAPIN'S PUFF'N'STUFF	F Sable Brown	Hal Smith
COLONY'S SUSANNAH OF BROWN WATCH	F Sable Brown	J.M. Sutherland
DAKA'S PYEWACKET	M Sable Brown	Robin Buell
GINGERWOOD NIGHT-TRAIN	M Sable Brown	M/M H.R. Gordon
KEMLEN KEOWEE	M Sable Brown	M/M Harley Kemp
LE-ME-KARON'S NASHIRA OF TOPAZ	F Sable Brown	L. & B. Hart
LE-ME-KARON YMA OF LE SHIN-WIELER	F Sable Brown	J.W.Weiler & E. LeSchin
LOTUS EYES RIGHT	M Sable Brown	B. & M.Doernberg
PHI LINE LITTLE BIG MAN	M Sable Brown	P. & R.Sanftner
SENOJ PATENT PENDING OF TZAADI	M Sable Brown	C. Richardson
SENOJ SASPARILLA OF TAMRI	F Sable Brown	M/M W.E. Miller
SENSHU'S SAKURA	F Sable Brown	Kathy Maddox
SHAZAM'S PAKOKKU OF UNAMI	F Sable Brown	Nancy K. Glass
TOK-LAT'S CUTEY SARK	F Sable Brown	Joan Batchelor
TOK-LAT'S LITTLE AWFUL ARNIE	M Sable Brown	Joan Batchelor
TOK-LAT'S T.N.T. OF CIMARRON	F Sable Brown	Deanne K.Lucek



GR.CH. DAKA'S PYEWACKET OF BURMA MATAGOT, Sable Burmese male owned by Nadine & Jim Buell, California.

BIRMAN GRAND CHAMPION

GRISWOLD'S ROMAR OF BYBEE

M Blue Pt.

Anna L. Bybee

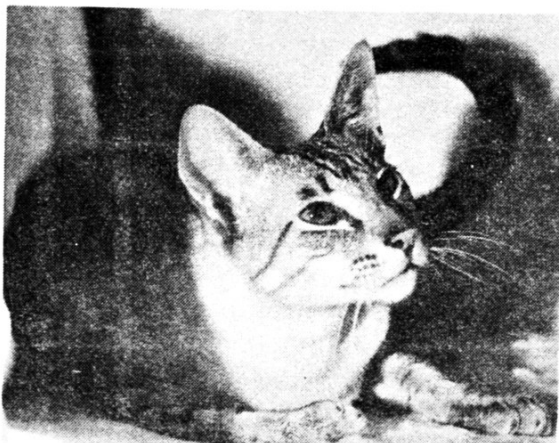
**COLORPOINT SH GRAND CHAMPION**

KASTL ROCK KOUNTRY BOY

M Lynx Pt.

E. & P. Collins

EXOTIC SH GRAND CHAMPIONS

DESERT COVE'S PANSY PUSS

F Blue Cream

Mrs. Jo Meyer

DOCIA-DAO'S TRILBY

F Black Smoke

M/M D.R. Yoder

GAY-O'S NAUGHTY LASS OF HI-CAMP

F Shaded Silver

M. & K. Campbell

TAMRI'S TROLLEY

M Black

Elaine Miller

VIENNESE'S WHITE VELVET

M B-E-White

Heidi Green

HIMALAYAN GRAND CHAMPION

Lord Byron

M Seal Pt.

A. & D. Sand

KORAT GRAND CHAMPION

CH'UN CH'I'S MEI WEI TE OF LOBI

F Blue

W. W. Anderson

GR.CH. KASTL ROCK KOUNTRY BOY, bred & owned by Ed & Pat Collins, Oregon, is C.F.A.'s 1st and only Lynxpoint Grand and 1973 Best Colorpt. SH.

MANX GRAND CHAMPIONS

BO-LIN TIGGER OF TRA-MAR

M Red Tabby

J. Bolin & M. Hall

BRIAR-BRAE MOUSA OF CHOM CHAI

F Black

M/M T.L. Baugh

BRIAR-BRAE MUJERCITA OF TAWILLI

F Tortie

James S. Noblin

COPPERBEECH BUTTERNUT

M Crm. Mk. Tby.

Mrs. K.E. Jensen

GLENDOWER'S SUSAN MARGARET

F Tortie

H. & R. Gramling

KELSHA JILL

F C-E-White

J.D.K. Shaw

KELSHA LILY

F C-E-White

J.D.K. Shaw

KELSHA MAJA

F Brown Tabby

J.D.K. Shaw

MARI-CAL BINKI-RULES

F C-E-White

H. & R. Gramling

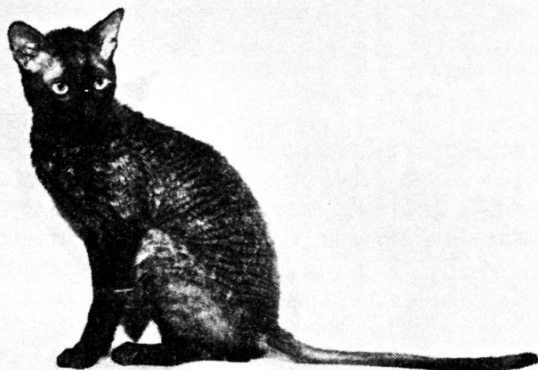
**REX GRAND CHAMPIONS**

NIKE GLIMMER OF CHALONAI

M Blk. Smoke M/M S. Wilson Jr.

SHY-ANN'S RED BARON OF MILL-CREEK

M Rd. Mk. Tby Ann Kimball

THALIA RAVISSANT OF RODELL

F C-E-White B. & D. Smith

GR.CH. NIKE GLIMMER OF CHALONAI Black Smoke Cornish Rex male owned by Dr. & Mrs. S. Wilson, Jr., Missouri. Curtis photo.

**RUSSIAN BLUE GRAND CHAMPIONS**

CAR-MAC PJATER

M Blue

Mrs. R.E. Carr

CAR-MAC THORN

M Blue

Mrs. R.E. Carr

FESENBRAD'S CZARVITCH RIMSKY

M Blue)

R. Bradshaw & A.

FESENBRAD'S CZARVITCH YURIC

M Blue)

Fesenfeld

HY-LINE'S SHINING COUNT

M Blue

Wm. B. Palmer

HY-LINE'S SILVER CLOUD

M Blue

Wm. B. Palmer

KIT-KAN LUBOV OF SATIN SONG

F Blue

M/M R.F. Burke

MERI-ROSE NICHOLAI OF LEHIGH

M Blue

D. & C. Ward

GR.CH. KIT-KAN LUBOV OF SATIN SONG, Russian Blue female owned by Anne & Bob Burke, W.Va.

SIAMESE GRAND CHAMPIONS

AL-E AURORA OF TOSA

F Lilac Pt.

S. Tanehsakdi

CASTO'S ZEB'ENY DOODAH OF ARIEN

M Seal Pt.

Joyce Casto

CHE'REE'S KEMSU OF SIN-CHIANG

F Seal Pt.

M. & B. Crotzer

CHE'REE'S CABARET

F Seal Pt.

S. & J.F. Bender

DIECE LADY MOSQUITO

F Lilac Pt.

M/M B. McDonald

FELITAN PSYCHE

F Seal Pt.

D. Levitan

FELITAN ARGENTIA OF WHITE ACRE

F Blue Pt.

D. & C. Sacks

SIAMESE GRAND CHAMPIONS (CONTD.)

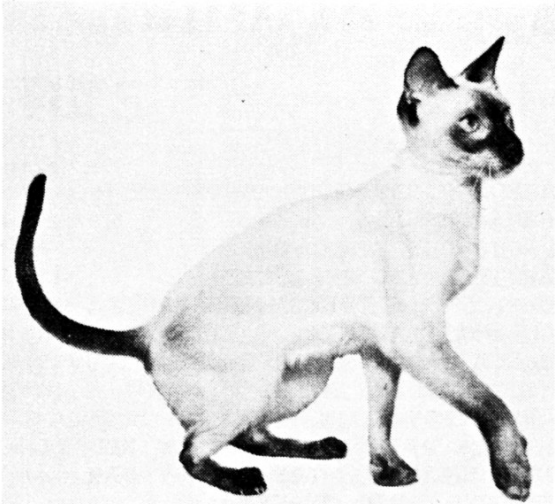

GR.CH. KEBO'S STANDING ROOM ONLY, Choc. Pt. Siamese female bred & owned by Ken Richey, Jr., Ky.
Curtis photo

HASUL'S AVIA
HUTZLER'S MISS DEMEANOR
IN LIEU TENLEY OF KARNAK
JO-SAN'S THEIA OF DA-CAR
KARNAK ARRIBA
KARNAK BLUE SCARAB
KEBO'S STANDING ROOM ONLY
LESNELLS ROXI-ANNE
LIN-HOW-SAN'S CARA LYN
LIN-HOW-SAN'S BRAZILIA LYN
LIN-HOW-SAN'S MISSLYN

F Lilac Pt. M/M M.K. Becker
F Seal Pt. Walter Hutzler
F Blue Pt. M/M Steven Karr
F Lilac Pt. D. & C. Coito
F Seal Pt. M/M Steven Karr
F Blue Pt. M/M Steven Karr
F Chocolate Pt. Ken Richey, Jr.
F Seal Pt. L.B. Carpenter
F Seal Pt.) Betty, Lew &
F Seal Pt.) Lynn
F Blue Pt.) Rabinowitz

GR.CH. YING THAI OF WINDY COVE, Lilac Pt. Siamese female owned by Cathleen Martin, Maryland.

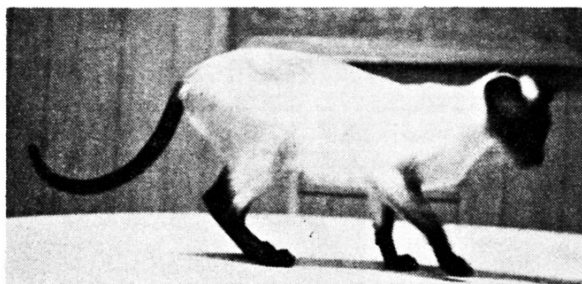

GR.CH. LESNELLS ROXI-ANNE, Seal Pt. Siamese female owned by Laurilie Carpenter, Washington.

MALOJA'S SABRINA OF VIBRANT
NOR-BOB'S KARIMA
PETMARK MOCHA
QUIN-JO'S QUINTESSA OF SHARA
RIKKA CHARISMA OF MAI SIN
SAN-TOI'S BLU FANCY OF BOGRAE
SAN-TOI'S MISTIQUE
SANTANA'S PODGORNÝ
SERENDIPITY BOO-KOO MOCHA
SIA-MEWS MISS BONNIE OF OPHIR
SHERA LEN JOY LUCK
TAP-TOE DANETA
TAP TOE JUBILEE
TRES BIEN TRICIA OF ROGERS HTS.
WILA-WAY'S MELANIE
YING THAI OF WINDY COVE

F Lilac Pt. M/M R. Goltzer
F Chocolate Pt. N. & B. Salzman
F Seal Pt. P. & V. Markstein
F Blue Pt. S.A. Kapilian
F Seal Pt. W. & H. Sheffey
F Blue Pt. G.C. Forrest
F Lilac Pt. Deanne Johnson
M Lilac Pt. R. & R. Rogers
F Chocolate Pt. M. M. Runnion
F Seal Pt. M.L.H. Nolan
F Seal Pt. Betsy Arnold
F Blue Pt. L.E. Dzbanski
F Seal Pt. L.E. Dzbanski
F Seal Pt. C.D. & C.J. Roger
F Blue Pt. Mrs. Pat Brown
F Lilac Pt. C.M. Martin

PERSIAN GRAND CHAMPIONS---SOLID DIVISION

AN-JU CARMEN	F Cream	M/M F.E. Anderton
BABALONG LOVE BUG	M B-E-White	Roxanne Long
BABALONG PHANTOM OF EN ALA ACEM	F B-E-White	Ron & Joan Luke
BEN-MAR MOON DUST	M Blue	M/M B.G. Ehrhardt
BEN-MAR SANDLEWOOD	M Cream	M/M B.G. Ehrhardt
BIRCH HAVEN PROMIS OF FLO-SHER	F Blue	M/M E.S. Cox
BLAZE SHOWDOWN	M Black	M. M. Fowler
CASTILIA PEKOE DOLL OF NOR-MONT	F C-E-White	Mrs. M.E. Hoag
CASTILIA SENSATION OF NOR-MONT	F Cream	Mrs. M.E. Hoag
CATSPURR'S COH-LEE OF TAY-BAR	M Black	T. & B. Taylor
CHAROE'S MUFFIN MAN OF NOTRECHAT	M Cream	R.L. Alexander
CHAROE'S ASMO OF HIMA-TAB	M Black	R.L. Alexander
CEE CEE'S WEE TREASURE OF SERBS	M Black	M. & R. Raich
DUNHWA'S PLAYBOY OF TRA-MAR	M Blue	W. Derouin & M. & D. Hall
FLO-SHER ORNAMENT OF NOR-MONT	M Cream	Mrs. M.E. Hoag
FOUNTAINHEAD ULTRA VIOLET	F Blue	M. Quealy
GATNEL'S PIDI PAT OF SNOBERRY	F Blue	R. Schnaubert
IOWANA HELLO DOLLY	F Blue	M/M D.R. Bromwell
JAMES' CATINET SEBASTIAN	M Red	Norma L. James
JAMES' CATINET MOJO OF KEYSTONE	M Black	P. C. Shenk
JUSTINCASE JO JO OF RAMBO	M Cream	J. & J. Rambo



GR.CH. KALAMAR ZYPR, Black Persian male bred & owned by Cal & Marge Lee of Washington.

(CONTINUED ON PAGE 22)

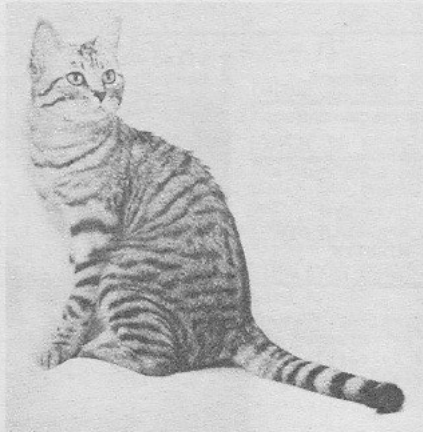

GR. CH. JELLIA JAMB OF SAREN-DEL, #7 cat in C.F.A., bred by Mrs. Wm. Wuesthoff & owned by Mary McIntyre, became a Grand in one show in March, 1972, at Kansas City. Born April 13, 1971, she has been a Top 5 winner 74 times, including 17 Best Cat awards. She is one of 3 existing Silver Mackerel Tabby C.F.A. Grands, along with her brother, TOM TERRIFIC OF SAREN-DEL, and SAREN-DEL'S CAPRICE.

C.F.A. National Awards, 1972 - 1973

BEST CATS

RANK	CAT	BREED/SEX	OWNER	AWARD
1.	GR.CH. PHAROH CITATION OF SWINGATE	Ruddy Abyssinian m	R. S. Everett	\$300
2.	GR.CH. KARNAK ARRIBA	Seal Pt. Siamese f	Dr. & Mrs. S. Karr	200
3.	GR.CH. APACHE CHIEF MATEO	Silver Tby. ASH m	A. L. Poeltl	150
4.	GR.CH. CASTILIA RED TREASURE	Red Persian m	M. Myers & M.E. Hoag	140
5.	GR.CH. TOK-LAT'S LITTLE AWFUL ARNIE	Sable Burmese m	J. Batchelor	130
6.	GR.CH. LOWLANDS LATECIA OF KITTRIK	Blue Persian female	L. Willwerth & D.Bandy	125
7.	GR.CH. JELLIA JAMB OF SAREN-DEL	Silver Mack. Tby. ASH	M. McIntyre	120
8.	GR.CH. MISTY MORNIN' MARTY	Black Persian m	C.P. Milwain & L.M.Swope	115
9.	GR.CH. LORD BYRON	Seal Pt. Himalayan m	A. & D. Sand	110
10.	GR.CH. SHAWNEE PAINTING THE TOWN RED II	Red Persian f	N. Horner	105
11.	GR.CH. CATSPURR'S COH-LEE OF TAY-BAR	Black Persian m	T. & B. Taylor	100
12.	GR.CH. PELITAN PRODO OF PETMARK	Blue Pt. Siamese m	P. & V. Markstein	95
13.	GR.CH. ROCOCO RUBY PETUNIA OF ADAM'S RIB	Tort. ASH f	A. Frecowski	90
14.	GR.CH. CASTILIA PEKOE DOLL OF NOR-MONT	CEW Persian f	M. E. Hoag	85
15.	GR.CH. JB BLACK STAR OF SILVA-WYTE	Black Persian m	Mr. & Mrs. W.W. Lanier	80
16.	GR.CH. SHAWNEE WHITE WASH	CEW Persian f	N. Horner	75
17.	GR.CH. KEMLEN KEOWEE	Sable Burmese m	Mr. & Mrs. H. Kemp	70
18.	GR.CH. DOCIA-DAO'S TRILBY	Blk.Smoke Ex.SH f	Mr. & Mrs. D. R. Yoder	65
19.	GR.CH. LOWLANDS GEORDIE	Blue Persian m	A. D. Bandy	60
20.	GR.CH. FONGIN CHOP SOY	Sable Burmese m	J. & E. Cattlin	55



GR. CH. APACHE CHIEF MATEO, #3 cat in C.F.A., bred and owned by Alayne L. Poeltl, became a Grand at 9 months by winning 224 Grand points in March, 1972, at the Erie Shore Cat Fanciers show. That season, in the Great Lakes C.F.A. Regional Awards, APACHE CHIEF MATEO was both Best Kitten and 6th Best Cat. The Silver Tabby is currently rated the Best Cat in that Region. His sire is CH. APACHE CHIEF LOBO, dam is CH. APACHE PETA.

Photo by Brown Studios

BEST PREMIERS

1.	GR.PR. KITTRIK'S BON-ANGEL OF WILA-BLITE	CEW Manx Spay	B.R. Collins	\$75
2.	GR.CH. & GR.PR. VI-JON MISS PARIL OF BEN-MAR	Blue Persian Spay	Mr. & Mrs. J. Byrne	50
3.	CH. & GR.PR. KILLARNEY'S IRON MIKE	Red Persian Neuter	L. L. Buel	40
4.	CH. & GR.PR. RUTHSBOGGS LORLEI OF HAPPY DAYS	Chin.Silver Pers.Sp.	G. I. Roberts	30
5.	GR.PR. MIDGIT	Calico ASH Spay	L. L. Buel	20

BEST OF BREED OR DIVISION - \$50 each

Birman	GR.CH. GRISWOLD'S ROMAR OF BYBEE	Blue Pt. m	A. L. Bybee
Korat	GR.CH. LA-RU'S NGAHM LOOK	Silver Blue f	L.Herrick/S.Rabold
Shaded Persn.	GR.CH. WALNUT HILL JUNO OF GENGHIS KHAN	Silver f	J. Lee
Smoke Persian	GR.CH. CASTILIA V.I.C. OF NOR-MONT	Blue Smoke m	Mrs. M.E. Hoag
Tabby Persian	GR.CH. CO-MC CONPETTI CAKE	Brown Tby	J. R. Hall
P-C Persian	GR.CH. SHENNEN'S LUV BUG OF PRIM-PET	Blue Cream f	E. Prather
Colorpoint SH	GR.CH. KASTL ROCK KOUNTRY BOY	Brown Lynx Pt. m	E. & P. Collins
Manx	GR.CH. GLENDOWER DELILAH	B-E-W f	M. M. Thompson
Rex	GR.CH. THALIA RAVISSANT OF RODELL	C-E-W f	B. & D. Smith
Russian Blue	GR.CH. FESENBRAD'S CZARVITCH RIMSKY	m	R. Bradshaw/A.Fesenfeld

BEST KITTENS

1.	CASTILIA PEKOE DOLL OF NOR-MONT	CEW Persian f	Mrs. M.E. Hoag	\$100
2.	DOCIA-DAO'S TRILBY	Blk. Smoke Ex.SH f	Mr. & Mrs. D. Yoder	90
3.	MATA-BLU MIKKI OF MAR-REE	Tortie Persian f	Mr. & Mrs. W.W. Lanier	80
4.	WILLOW GLEN CHECKMATE	Cream Persian f	E. & J.A. Sandefur	70
5.	NOR-MONT TAFFY'S GOLDIE	Cream Persian f	Mrs. M. E. Hoag	60
Best LH Male:	HAWTHORNE MR. BIG STUFF	Black Persian m	R. Haussman, Sr.	25
Best SH Male (Tie):	CATH-SON'S DARBOI OF BOGRAE	Seal Pt. Siamese m	G.C.Forrest & J.& B.Quiner	25
	MIRIBU'S SILVER LINING	Russian Blue m	M. Mellies	25

BEST OF COLOR - \$10 each

GR.CH. SHAH-AN-SHAH AFSANEH-AMIZ	B-E-W Persian	L. Heron
CH. MARGATE'S HY-LITE OF GOLD MEDAL	O-E-W Persian	R. & F. Clark
CH. KEN-JU'S FEELIN' GROOVY OF MARLITA	Peke-Fc.Red Persian	Mr. & Mrs. M. Morris III
GR.CH. LOWLANDS ZEUS OF LIN LEA	Cream Persian	Mrs. R. Beery
GR.CH. BEAU GESTE COZETTE	Chin. Silver Persian	Mr. & Mrs. G.M.Ferrier
GR.CH. SHERLOCK OF PET SET	Black Smoke Persian	D. A. Kellams
GR.CH. TABBYLAND'S TALCUM	Silver Tabby Persian	B. R. Witbeck
GR.CH. SMITHWAY MAXIE	Red Tabby Persian	L. L. Smith
GR.CH. SMITHWAY DAVY CROCKETT	Pk-Fc.Red Tby.Persian	Mrs. H.M. Smith
GR.CH. KALAMAR'S FLARE OF FUR HAVEN	Tortoiseshell Persian	C. Russell
GR.CH. FERGUS' GO PUMPKIN OF DAVIRO	Shell Cameo Persian	Mrs. D. Dieter
GR.CH. SILVER DOLLAR'S SIR DRAKE	Shaded Cameo Persian	Mr. & Mrs. O.E. Ferris
CH. PITT'S PEAU DE SOIE OF LORA-LI	Blue Pt. Himalayan	Mrs. M. Herold
CH. BEACH HAVEN PASTEL	Blue-Cream Pt. Him.	J.A. Carvill
GR.CH. VOGUE'S SUNNY SIDE UP	Parti-Color Persian	S. Ellsworth
GR.CH. KITS' PEACHES 'N CREAM	Tortie Pt. Himalayan	Mr. & Mrs. E.Kitsmiller
CH. AN TAI LIS TYNKER-BELLE	Lynx Pt. Colorpt. SH	A. T. Longo
GR.CH. NOR-BOB'S KARIMA	Chocolate Pt. Siamese	N. & B. Salzman
GR.CH. SANTANA'S PODGORN	Lilac Point Siamese	R. & R. Rogers
GR.CH. DA-GLO'S RED BARON	Red Pt. Colorpt. SH	Mrs. E. Huffman
GR.CH. RUSTY RED OF ERIADOR	Red Abyssinian	L. & S. English
GR.CH. MARI-CAL BINKI-RULES	C-E-W Manx	H. & R. Gramling

GR.CH. ROSENTAL BLUE HERITAGE	Blue Manx	Mrs.H.W.Mayhew/D. & J.Thompson
GR.CH. LOVEBUNNY'S INDIVIDUAL	Silver Mk.Tby. Manx	A. A. Frahm
GR.CH. BO-LIN'S TIGGER OF TRA-MAR	Red Tabby Manx	J.Bolin/M. Hall
GR.CH. GLENDOWER'S LLEWELLYN MICHAEL	Red Mk.Tby. Manx	M. M. Thompson
GR.CH. BRIAR-BRAE MANGO	Tortoiseshell Manx	B. St. Georges
GR.CH. MAYFLOWER'S CHILD	O-E-W ASH	M. Slodden
GR.CH. ESQUIRE ESCAPE OF SHAWNEE	Black ASH	Mr. & Mrs. W.S. Barrer
GR.CH. MALMAR ARIES	Shaded Silver ASH	Mr. & Mrs. M. Peters
GR.CH. SANDEF'S CHINAMAN	Black Smoke ASH	E. & J.A. Sandefur
GR.CH. KAYVANA'S MAURIS OF BUSHOME	Red Tabby ASH	P. Bush
GR.CH. DUNN'S LEO MINOR	Brown Tabby ASH	J.Dunn/B.W. Negus
CH. LOWLANDS MAYBELLE	Blue Cream ASH	A. D. Bandy
GR.CH. CHIN HILLS ROB ROY	Cream Tabby ASH	J. A. Ford
GR.CH. MR. PETER PAN OF BAMS	Cameo Mk.Tby. ASH	N. & A. Silvers
GR.CH. RODELL'S RELILAH	Black Rex	Mrs. P. Christie
GR.CH. SEATIME MARI GOLD OF KENI KATZ	Red Rex	E.V. & C.T. Dyer
CH. NIKE ECLIPSE OF SHARTEBO	Black Smoke Rex	T. & S. Bolander
GR.CH. SHYANNS RED BARON OF MILLCREEK	Red Mk. Tby. Rex	A. Kimball
GR.CH. TAMRI'S TROLLEY	Black Exotic SH	E. Miller
CH. GRAYFIRE'S APACHE	Chin. Silver Ex.SH	Mrs.D.Walkingstick
GR.CH. GRAYFIRE'S POW-WOW OF CINDYLOU	Shaded Silver Ex.SH	C. Roberts
GR.CH. DESERT COVE'S PANSY PUSS	Blue Cream Exotic SH	Mrs. J. Meyer

PERSIAN GRAND CHAMPIONS--SOLID DIVISION (CONTD.)

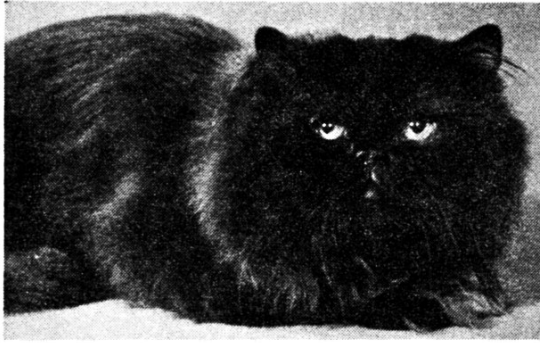

GR.CH. RA-LE MUFFIN'S SHADOW OF SUZANNE, Black Persian male owned by Suzanne Schabel, New York.

RIDGEMONT LADY GALADRIEL	F C-E-White	Nancee Beamer
SHAH-ANSHAH AFSANEH-AMIZ	F B-E-White	L. Heron
SHEDARON'S TIMOTHY OF SULTAN	M Cream	L. & M. Hall
SHOW ME THE FRITO BANDITO	M Cream	C. Marshall
SIMBELAIR MUSE OF KUKKULA ACRES	F C-E-White	M/M G.M. Hendrickson
SURFSIDE PAULA OF NOR-MONT	F C-E-White	Mrs. M.E. Hoag
SYLVA-LEE'S IMAGE OF J OF RAY-MAR	M B-E-White	R. & M. Masters
TI-SAI'S LITTLE DAWN	F Blue	S. Stockwell
TRA-MAR'S KARMELO KID OF ABBEY ROAD	M Cream	D. & M. Hall & S. Cook
TU-LUSE LATRICK OF A.J.	M C-E-White	M/M R.B. Rodefer
VI-JON JEWEL OF IOWANA	F Blue	M/M D.R. Bromwell
VOGUE'S SUPERSTAR OF WOODSTOCK	F Cream	M. Quealy
WILLOW GLEN'S FIRE FLY OF JA CA TO	F Red	Mrs. J.D. Bragg
WILLOW GLEN'S KID CURRY	M Red	N. Horner

M Black	Cal & Marge Lee
F C-E-White	Kathleen Kay
M C-E-White	T. & E. Brown
M Black	Evelyn Prather
F Cream	M. K. Carroll
M Blue	A. D. Bandy
F Blue	D. & G. Ingalls
M Black)	C.P. Milwain &
F Cream)	L.M. Swope
M Blue	M/M J. Bradley
F Blue	Mrs. R. Klotz
M Blue	Mrs. R. Klotz
M Cream	M/M J.S. Todd
M Red	H. & M. Gay
M Black	Sue Schabel

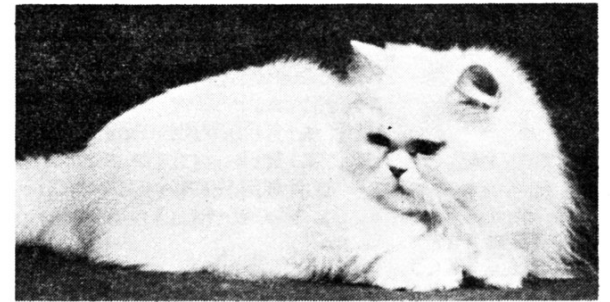

GR.CH. RIDGEMONT LADY GALADRIEL, Copper-Eyed White Persian female owned by Mrs. James H. Beamer, Texas.

PERSIAN GRAND CHAMPIONS---SMOKE DIVISION

CATSREALM BIENQUISTA	F Blk. Smoke	Mrs. E.K. Davis
SHERLOCK OF PET SET	M Blk. Smoke	D. A. Kellams

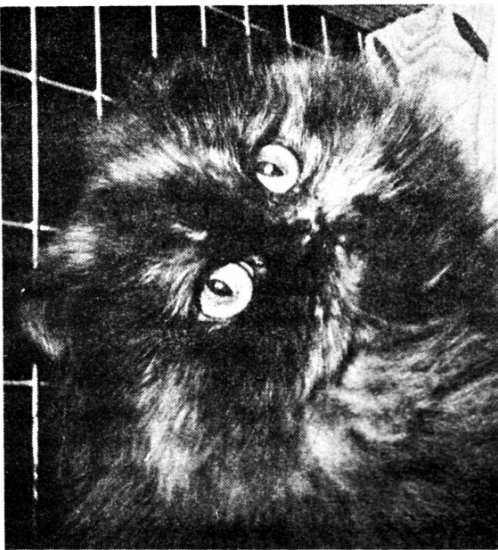

GR.CH. KIMBERLEA SWEAPEA OF LARRANDA, Tortoiseshell Persian female owned by Audrey Harlow, Virginia.

PERSIAN GRAND CHAMPIONS---PARTI-COLOR DIVISION

KIMBERLEA SWEAPEA OF LARRANDA	F Tortie	A.C. Harlow
KOHINOOR MUSE	F Blue Cream	M. K. Carroll
MERCHANT'S BUBBLES LA-TOUR	F Blue Cream	G.R. Merchant
MERILAND'S TEALA OF MYTH	F Tortie	Mrs. Y.R. Tessmann
MISTY MORNIN' LALIQUE	F Blue Cream	C.P. Milwain & L.M. Swope
MIVERSNIT'S BABI-TEE OF ROTHGEB	F Blue Cream	B. Webb & M/M P. Horan
NEVERON'S STRAWBERRY FIELDS	F Tortie	S. & N. Shulman
PERRY ACRE LADY FAN TAN	F Tortie	T. Perry
SHENNEN'S LUV BUG OF PRIM-PET	F Blue Cream	Evelyn Prather
SILVA-LEE LORI OF THORNLEA	F Blue Cream	G. R. Case
SIMBELAIR MEISHA	F Blue Cream	M/M S. Weston
SURFSIDE WONDER DOLL	F Blue Cream	R. & S. Stevens
VOGUE'S SUNNY SIDE UP	M Bi-Color	S. Ellsworth
WIL-O-ROSE COVER GIRL	F Blue Cream	W. & R. Herrmann
WINETA'S CHARADE	F Blue Cream	J. & F. Jeffries
WOODLAND GLORY	F Blue Cream	Gayle Wood
WYNDEN'S SKYLARK OF SILOUETTA	F Tortie	M/M W. Gamblin

Wyldeewood

S
I
L
V
E
R

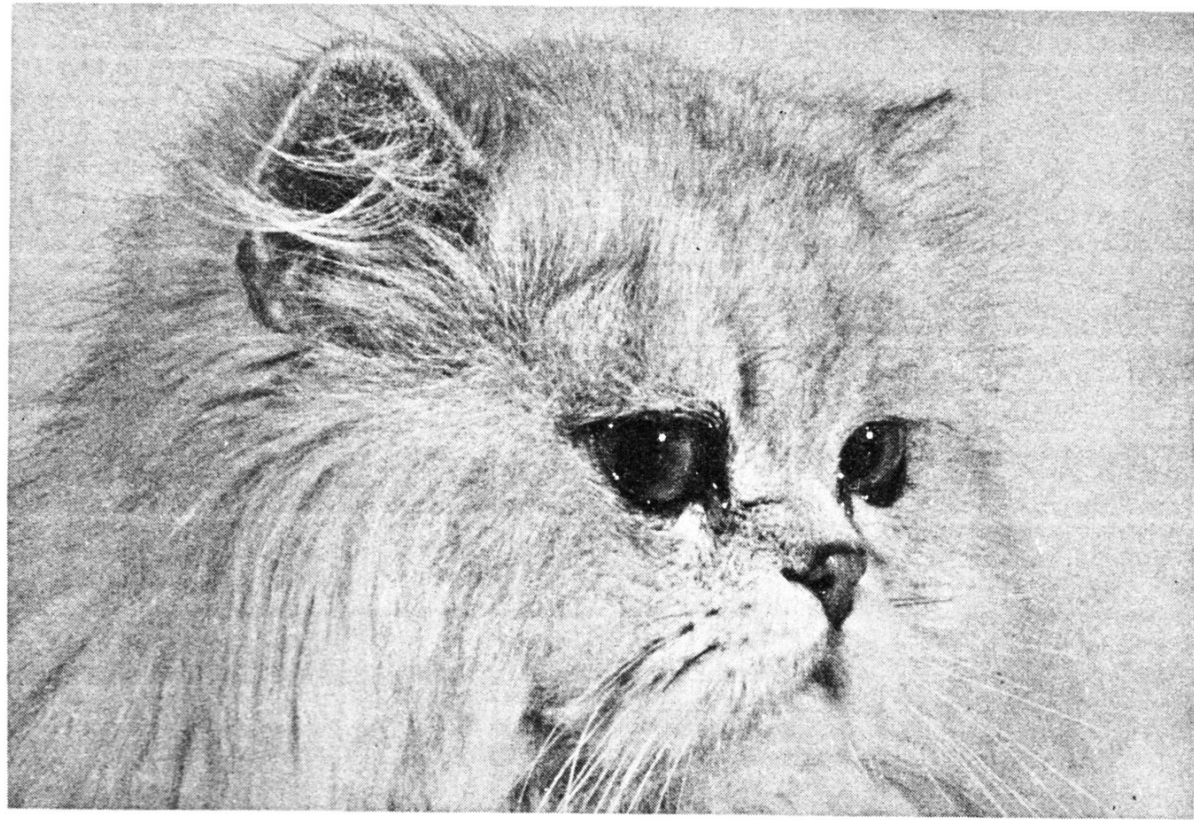

P
E
R
S
I
A
N
S

CH. KITZA CRESCENDO OF WYLDEWOOD

*Top Show; Show & Breeder
Kittens & Cats Available*

OUR PET STOCK IS SOLD LOCALLY TO BE ALTERED & WITHOUT PAPERS.

GR. CH. WALNUT HILL FLUTE OF WYLDEWOOD

BEST IN SHADED DIV., BEST CHINCHILLA, SOUTHERN REGION, C.F.A.

4 SHOWS---MIAMI BEACH, ORLANDO, SAVANNAH, MIAMI---
PRODUCED FINAL WINS C.F.A. 12 OUT OF 16 RINGS PLACING
AMONG TOP 5 EACH TIME.

Wins were with FLUTE, CH. WYLDEWOOD'S YOUNGER THEN SPRING,
CH. WYLDEWOOD'S JENNIFER, CH. KITZA CRESCENDO OF WYLDEWOOD
and WYLDEWOOD'S C'EST MOI (our kitten).

Doug Brenner & Don Salamone

6308 S.W. 26 STREET, MIAMI, FLA. 33155

305-667-4059

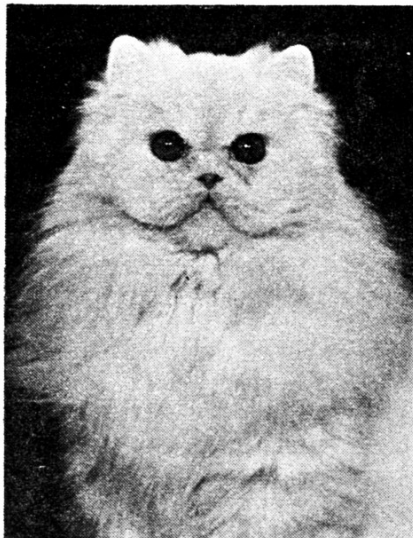

Curtis photo.

PERSIAN GRAND CHAMPIONS---SHADED DIVISION

DORKER'S PINK HYACINTH OF MINUET	F Shell Cam. Mrs.C.O. Talley
EEE-DEE LITTLE TID-BIT	F Chinchilla Edith Price
FERGUS' GO PUMPKIN OF DAVIRO	F Shell Cam. Mrs. D.Dieter
GEOR-AL FONGEE	M Chinchilla L.L. Pearson
JUBILEE'S BEAUREGARD	M Sh. Silver S. Graziani
SANSKRIT SECRET OF FAYRON	F Chinchilla M/M R. Acosta
SARINDA'S LONG JOHN SILVER	M Sh. Silver S.& E.Abernethy
SILVER-SWAN ECHO OF MARLBORO	F Sh. Silver W. H. Kelly
SUMMERSET GAYLORD	M Sh. Silver B. A. Lovelance
WALNUT HILL BEAUREGARD	M Sh. Silver Mary Caito
WALNUT HILL KEWPIE DOLL	F Chinchilla Mrs. R.Weston
WICKLOW'S HIMSELF OF SILVERLACE	M Sh. Silver M/M M.Greene

GR.CH. FERGUS'S GO PUMPKIN OF DAVIRO, Shell Cameo Persian owned by Mrs. David Dieter, Minnesota.

GR.CH. JUBILEE'S BEAUREGARDE, Shaded Silver male owned by Shirley Graziani, Ontario, Canada.

GR.CH. WICKLOW'S HIMSELF OF SILVERLACE, Shaded Silver male owned by Mr. & Mrs. M. Greene, Ill.

GR.CH. YOUR PETS STORM CLOUD OF FANFAIR, Silver Tabby Persian female owned by Laird Lemire, B.C., Canada.

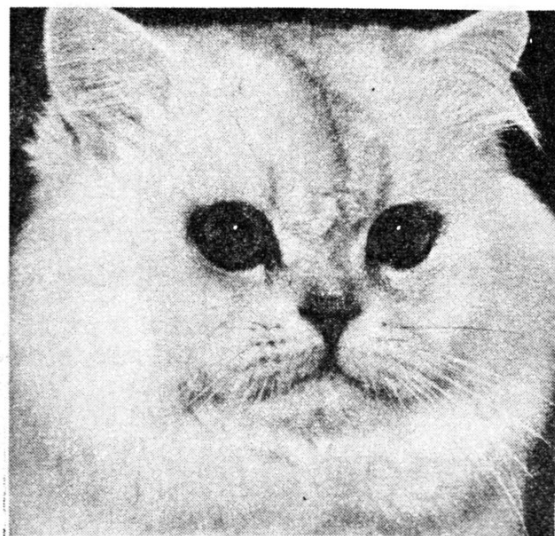
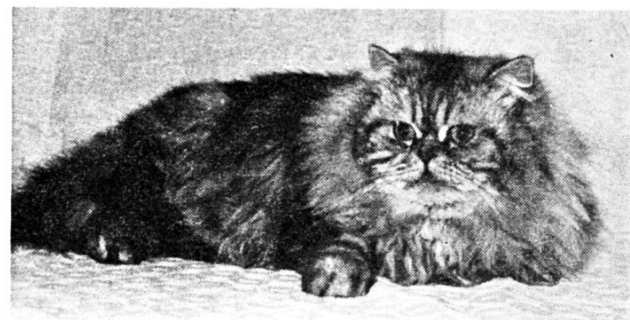
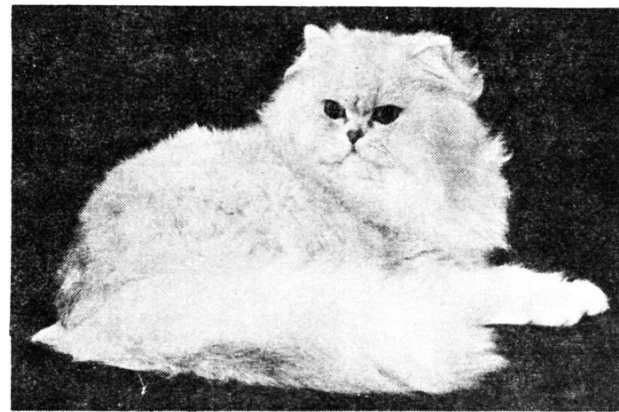

PERSIAN GRAND CHAMPIONS---TABBY DIVISION

CO-MC KISRA OF GENIMA	M Brown Tby. Mrs.G.E.Thompson
JUMBIES SNAPDRAGON OF YOUR PETS	F Brown Tby. Mrs. D. Baker
SILVER WILLOW'S DON ROI OF DUNCAN	M Brown Tby. Mrs. K.Duncan
SMITHWAY DAVY CROCKETT	M Pk.F.Rd.Ty.Mrs.H.M. Smith
SMITHWAY MAXIE	M Red Tabby L.L. Smith
TABBYLAND'S TALCUM	F Silver Tby.B.R. Witbeck
TABBYLAND'S TOBY	M Brown Tby. B.R. Witbeck
WYNDEN'S ROBIN	F Brown Tby. Mrs.J.K.Pevey
YOUR PETS' STORM CLOUD	F Silver Tby.Laird Lemire
YOUR PETS' LEM-MEE	M Brown Tby. Mrs. D. Baker



GR.CH. SMITHWAY DAVY CROCKETT, Peke-face Red Tabby Persian male owned by Mrs. Helen Smith, Calif.
Jan Claire photo

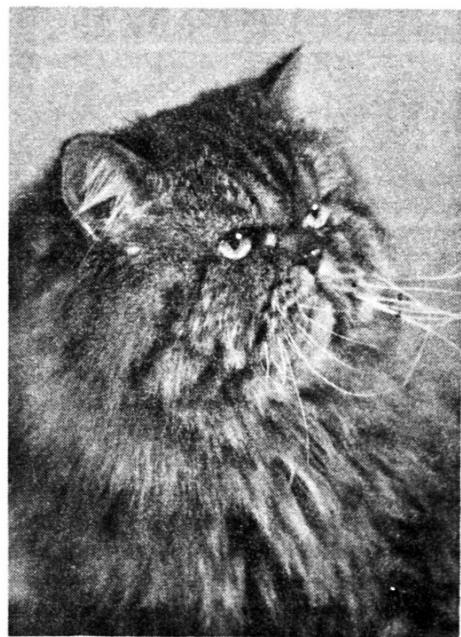

GR.CH. SILVER WILLOW'S DON ROI OF DUNCAN, Brown Tabby Persian male owned by Mrs. Kenneth Duncan, Nebraska.
John Kalina photo.

Brock' Ann Cattery

CFA & ACFA

STUD
= SERVICE =

SPECIALIZING IN LILAC

& BLUE SIAMESE

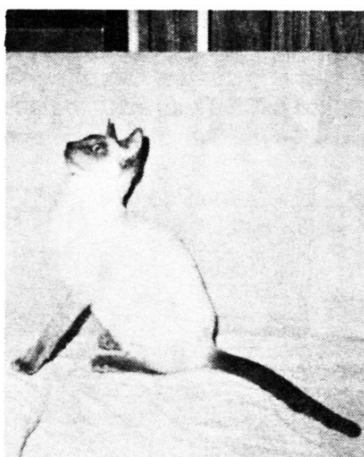
ANN M.
BROCKLEBANK3536 EVERGLADES RD.
LAKE PARK, FL. 33403
Phone: (305) 622-1534

CH. & DBL.CH. JO-SAN'S ZENO OF BROCK'ANN,
Lilac Pt. Sire: Gr.Ch. San-Toi's Beau-
Mondel Dam: Gr.Ch. Jo-San's Telesia.

HO-CO-MO Himalayans

SEAL - BLUE POINT

STUD SERVICE

KITTENS

BREEDING FOR

PERSIAN TYPE.

HO-CO-MO SHANNON
S.P. Female

SERIOUS INQUIRIES, PLEASE. PROMPT REPLIES.

HUGH & MARY OLANDER

265 RICHNECK ROAD, NEWPORT NEWS, VA. 23602
Phone: (804) 877-2887

GALLERY OF C.F.A. GRAND CHAMPIONS (CONTD.)

BURMESE GRAND PREMIERS

BROWN BUN	S Sable Bn.	Joan Culpepper
CHU-LIN-JON'S SU-LIN	S Sable Bn.	Judy Kennedy
ERIADOR'S GILLY BROWNLOCK	S Sable Bn.	L. & S. English
LOCHINVAR'S YONA BLOSSOM	S Sable Bn.	M/M J. McKendrick
PHI LINE LIBRA OF KAOS	S Sable Bn.	W. & D. Cummings

PERSIAN GRAND PREMIERS

CASTILIA THE WHITE DRAGON	N C-E-White	Nancy Davis
KANDI I	S Chinchilla	M. Puccinelli
PURR-LINE'S HI-HOPES	N Chinchilla	C. Donovan
RUTHSBORGS LORLEI OF HAPPY DAYS	S Chinchilla	G. I. Roberts

SH GRAND PREMIERS

LE SABRE SILVER CHARM OF SHAWNEE	S Silver Tby. Am. SH	T. W. Tucker
NORPARKS CALIENTO OF RIO VISTA	S Sh.Sv.Ex.SH	E.R. & S. Ironside
MIAMANX LITTLE KATE OF KELSHA	S Bn.Tby.Manx	J.D.K. Shaw
SUTTER'S BLUE TWIG	S Bl.Pt.Sia.	Mrs.W.D. Sutter

(CFA) I - A M - S I A M (ACFA)

BLUEPOINTS

FROSTPOINTS

THE NEW CATTERY SPORTING:

ENGLISH IMPORTS FROM CHAMPIONSHIP LINES

SCANDINAVIAN CATS FROM CHAMPIONSHIP LINES (SAN-T-REE)

KITTENS AVAILABLE IN SEPTEMBER.

SHOW AND BREEDER QUALITY.

Sire: R.M. TR.GR.CH. & CFA CHAMPION
FLUME WIRREE OF ANGLO-TEX, IMP. (AT STUD)

Dams: DBL. CH. TAURUS KANDIE KISSES OF BODANTE
CFA CHAMPION I-AM-SIAM'S TUULIANA

ELIZABETH SMITH - 2565 SO. HIGH ST. - DENVER, COLO. 80210
Tel: 1-303-778-1401



Your Pets Storm Cloud Of Fanfare

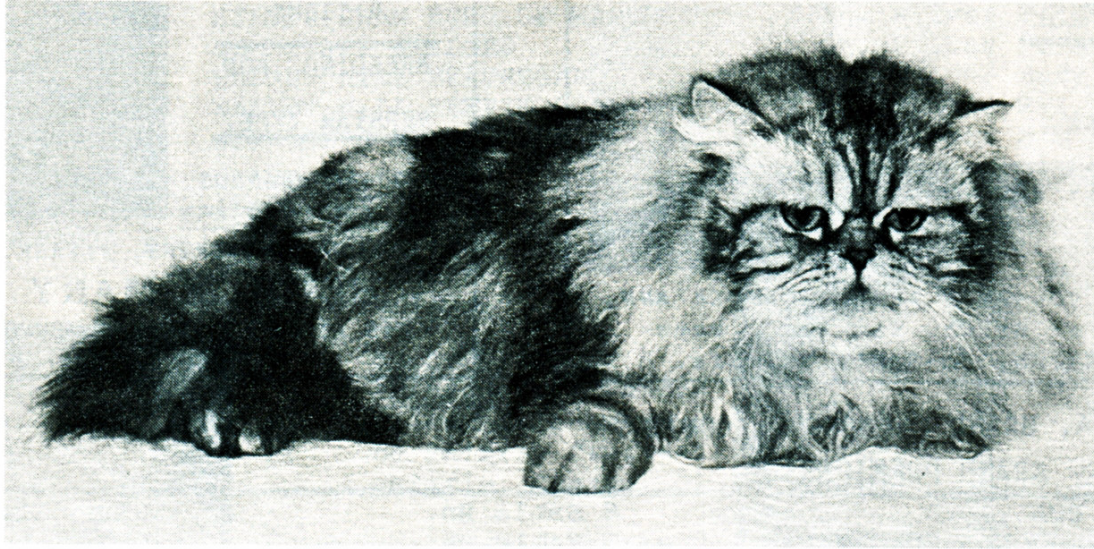

CFA's 1st Silver Tabby Persian Grand Champion

BY LAIRD LEMIRE

When breeders and show people think of 'silver tabbies', there is almost an immediate association with 'American Shorthairs'. This is because so many outstanding specimens of Silver Tabby American Shorthairs have appeared at shows for many years. They have been shown to 'Best Cat' many times and, on several occasions, have gone on to become 'Cat of the Year'.

Recently greater interest is being generated in the development of this colour in other breeds; quality silver tabbies are being shown in Rex, Manx, Exotics and Persians. Judges, too, have usually been receptive, and indeed enthusiastic, over finding fine examples of silver tabbies in these breeds.

This past show season, *YOUR PETS STORM CLOUD OF FANFAIR* became the first Silver Tabby Grand Champion in the history of the Cat Fanciers Association.* She completed her Grand Championship at the Daffodil Valley Cat Fanciers' show, Tacoma, Washington, January 13-14, 1973. Her success indicates that the Persian can be bred in this colour to compete with even the typiest solids.

GR.CH. YOUR PETS STORM CLOUD OF FANFAIR was born on May 19, 1970. She was bred by C.F.A. judge, Mrs. Dorothy Baker, who has been working almost alone on the Silver Tabby Persian for close to twenty years. *LOUDY* has a fine pedigree with Co-Mc, Shawnee, Nigrette and Skyway figuring prominently in her Background.

Typewise, *LOUDY* is a big girl with solid, heavy boning, short legs and a beautifully short tail. Her head is very broad, with widely spaced ears and large round eyes. She has a strong chin, and a lovely deep "break" in her short nose. Her eye-colour is hazel, correct for a Silver Tabby Persian for it is near to impossible to obtain black markings and green eyes in the same cat if it is to be typy as well.

When I received her from her breeder in January, 1972, I found that her disposition is as it must be in a pet or show cat--quiet and sweet. Nothing seems to greatly upset her and she arrives unruffled after a long plane trip to a faraway show. She has gone from her home in British Columbia, Canada, to shows as far east as Calgary and as far south as Portland, Oregon.

Silver Tabbies have always been rare in Persians. Perhaps the struggle to keep green eye-colour while trying to improve type defeated most aspiring breeders. Judges now seem to realize how difficult it is to obtain both type and pattern---deep green eyes are just too much to ask. American Shorthairs did not have them, so why persecute the Persians?

Maybe this oversight can be forgiven since breeders and judges have been used to exceptional eye-colour in Persians for what seems eons and finding hazel eyes in the Silver Tabbies just 'turned them off'.

All methods of obtaining this lovely colour class, except colour-breeding, necessitates the use of copper-eyed Persians in the breeding program, usually to a great degree to keep 'solid' type. Crosses of a Silver to a Black, Black Smoke, Red or Brown Tabby can, theoretically, produce Silver Tabbies, but these are many times lacking in pattern and can show traces of tarnishing (brownish tinges) in the coat, especially on the face and down the spine.

Breeding Silver Tabby to Silver Tabby is usually not feasible due to the shortage of quality stock. Males seem especially rare and the author knows of only one sire male Silver Tabby of good show quality. Breeders are, therefore, forced to 'go through hoops'

to develop their line. Most give up before an end is realized.

There have been a few outstanding examples of this colour of breed in the past, practically all from Dorothy Baker's line. *CH. YOUR PETS' MEESE* and her daughter, *CH. YOUR PETS' SEE MEE* are both excellent. *SEE MEE* has over 200 C.F.A. Grand points but, because of the rules, recently changed, requiring a Top Five and Best Champion win in C.F.A., she couldn't complete her Grand. She should have no trouble now. In the East, there are two other lovely Silver Tabby females, *TABBYLAND'S TEQUILA OF RAY-ANN* and *TABBYLAND'S TALCUM*, litter-sisters bred by Mrs. B. Witbeck, who are both climbing to top show wins.

GR.CH. YOUR PETS' STORM CLOUD OF FANFAIR recorded another C.F.A. 'first' by becoming the first Silver Tabby Persian to go Best Cat in an All Breed final. This honor was accorded her by judge Ray Henke at the Red 'N Ruddy Happening show, Everett, Washington, December 2, 1972.

Other top C.F.A. awards she has received during her show career have included: Best Kitten (Matil Rotter, Canton Hall of Fame, January 2, 1971); Best Novice Opposite Sex (Don Williams, Johnny Appleseed, February 6, 1971); 5th Best Cat (Ray Henke, Red 'N Ruddy, March 19, 1972); 4th Best Cat (Catherine Hummer, Red 'N Ruddy, March 19, 1972); 5th Best Cat (Wayne Park, Fraser Valley, April 15, 1972); and 4th Best Cat (Jane Martinke, Puget Sound Cat Club, November 4, 1972). *LOUDY* was C.F.A.'s Northwest Regional Tabby Persian, 1972, and All Star Silver Tabby Persian, 1972.

YOUR PETS' STORM CLOUD OF FANFAIR has also earned a Grand Championship in A.C.F.A. who named her Royal Regional Silver Tabby Persian and Inter-American Silver Tabby Persian in 1972. Another 1972 title she was awarded was All-American Silver Tabby Persian.

It is very exciting to see good Silver Tabby Persians on the show bench after so many years of neglect. With all the new breeders showing such keen interest, it seems that we will be seeing a lot more of them. ###

*Inquiries and research by the author failed to reveal an earlier S.T. Persian Grand Ch.

Sire:

DBL.GR.CH. YOUR PETS'
CH. CO-MC'S LEMON SNAP
Brown Tabby

Gr.Ch. Co-Mc's Chess
Pie Brown Tabby

Ch. Co-Mc's Brown
Betty Brown Tabby

Ch. Minqua's Ginger
Snap of Co-Mc *Brn. Tby.*
Ch. Shawnee Amber of
Co-Mc *Tortie*
Ch. Minqua's Ginger
Snap of Co-Mc
Alta Prissy Pants of
Co-Mc *Blue Cream*

YOUR PETS' STORM CLOUD OF FANFAIR

Dam:

CH. YOUR PETS' SEE MEE
Silver Tabby

Ch. Zoom's Derby of
Your Pets' *Black*

Ch. Your Pets' Meese
Silver Tabby

Ch. Your Pets' Moose
Silver Tabby
Skyway's Sky Baby of
Zoom *Blue*
Ch. Your Pets' Moose
Silver Tabby
Phil-Bet's Jemara of
Your Pets *Silver Tby.*

College Of Cat Genetics

Patricia Turner

STUDY UNIT 3

Mendel chose the garden pea in his experiments probably because plant breeding was his hobby much as cat breeding is the hobby of many readers. The experiments he made were all with pure breeding pea plants, but cat breeders can probably understand them more easily if they are reconstructed with cats as the subjects under study. So if two cats known to be homozygous, one for black and one for blue are used to reconstruct Mendel's first experiment the processes and results are as follows:

THE 3:1 RATIO

In the first cross of a homozygous black cat with a homozygous blue cat the first generation progeny, known as the first filial generation and symbolized F₁, will be found to be all black. Black is dominant to blue and blue is recessive to black. The next part of the experiment crosses two of these identical black cats and produces the next filial generation, F₂. The kittens of the F₂ generation will be found to be black and blue in the ratio of 3 black to one blue. However, this is one point where Mendel's experience cannot be reproduced as he obtained 1064 pea plants in his F₂ generation and the likelihood of 1064 kittens resulting from matings between litter mates of F₁ litters are rather remote! However, the ratios remain the same. Many cat breeders would feel hesitant about mating littermates even in the course of an experiment, but of course the ratio of three black to one blue from heterozygotes applies even when the mates are not related. A mating between F₁ progeny can be taken to mean either between littermates or between cats of the same genotype as the littermates.

Thus it can be seen that in this experiment the recessive characteristic (blue) which disappeared in the F₁ generation, reappeared in the F₂ generation intact and not blended in any way with the black. The experiment suggests that the genes responsible for the production of black and blue are transmitted together to the F₁ kittens and are then separated and segregated in the F₂ kittens. The experiment also suggests that each gamete of the original parents contains two genes (either two black genes or two blue genes) and that the two genes then separate or segregate in the formation of gametes, each gamete receiving only one of the genes. If the gene producing black is described as D

Problems

The following problems are based upon information contained in Study Unit #2 published in the May/June issue of *CAT WORLD*. Solutions will be printed in September/October.

1. Why are the expressions "Champion's blood" and "diluting out" based upon misconceptions? Are the characteristics of a kitten inherited in its blood?
2. It is stated that the cat's coded instructions govern the nature of both the chemical ingredients from which it is made and the nature of the chemical changes in its body during its life. If the cat develops from a fertilized cell, in which part of the cell are the instructions carried?
3. Why has use of the symbol y (denoting the sex-linked colour gene producing the red and tortie varieties) been discontinued?
4. The gene producing extra toes (polydactylia) is symbolised Pd . Is this gene inherited as a recessive or as a dominant and how is this information given in its symbol?

SOLUTIONS TO MAY/JUNE "PROBLEMS":

1. 'In the cat there are 36 autosomes' The chromosome complement of the two types of gamete produced by the male cat are (a) 36 autosomes plus two X chromosomes, and (b) 36 autosomes, one X chromosome and one Y chromosome. (a) gametes will be female and (b) gametes will be male.
2. 'Why do genetic differences arise' Genetic differences arise during meiosis rather than from mitosis because mitosis is the normal type of cell division in which the cells divide in a manner resulting in all the daughter cells retaining the full complement of 38 chromosomes. But in the cell division that occurs just before the gametes are formed (meiosis), each daughter cell has only 19 chromosomes. It is only at fertilization, when the daughter cells from each partner unite, that the full complement of 38 is regained. Clearly the fertilized cells will have some chromosomes from each parent and will differ from those produced by each parent during mitosis. Mitosis

and that producing blue as d the original parents are DD and dd respectively. The gametes of the DD cat must be all D and the gametes of the dd cat must be all d . So all the F_1 kittens must inherit alternative genes Dd . Since D is dominant to d , Dd would appear as D or black. In the second generation (F_2) the gametes of one cat must be either D or d as must be those of its mate.

Mendel proposed that hereditary units (in this case D and d) segregated in the gametes and that the gametes themselves united at random. Thus the F_2 kittens must be either Dd like the F_1 parents or DD or dd like the original parents which are known as the first parental generation P_1 , and the ratio of one genotype to another in the F_2 must be $1DD:2Dd:1dd$. Since both DD and Dd kittens appear black, this results in F_2 progeny that are in the ratio of 3 black:1 blue.

These test matings reconstruct the experiments which led to Mendel's first law or principle of segregation, and help to explain that while cats may appear alike they may have a different coding. This distinction between appearance (phenotype) and coding (genotype) must often be made.

A reconstruction of Mendel's experiment is shown diagrammatically in next column.

The checkerboard, a Punnett's square, shown on end in the diagram is a useful aid to the cat breeder and the same experiment can be rewritten as follows:

- (1) Cat No. 1 = DD - homozygous black;
- (2) Cat No. 2 = dd - homozygous blue
- (3) The DD cat will produce gametes carrying D .
- (4) The dd cat will produce gametes carrying d .
- (5) Therefore fertilization of any one gamete by another will result in the genotype Dd and since D is dominant to d all the F_1 kittens will be black.

To obtain the F_2 a mating is made between the F_1 littermates or to unrelated cats of the same genotype as the F_1 littermates---each of these cats producing two types of

results in daughter cells with the same chromosome complement whereas meiosis results in daughter cells with half the chromosome complement.

3. 'Recessive Oregon Rex, recessive Cornish' No, a mating between an Oregon Rex queen and either a Cornish or Devon Rex stud will not produce any rex kittens. They will all have normal hair. The non-rex kittens produced will be carriers for both rex varieties as the three varieties of rex are non-allelic to each other.
4. 'In a litter from a Seal Tabby (or Seal Lynx) Point Siamese' The Tabby (or Lynx) Point kitten is heterozygous for agouti. The Seal Point kittens will never produce Tabby (or Lynx) Points if mated to Seal Points.

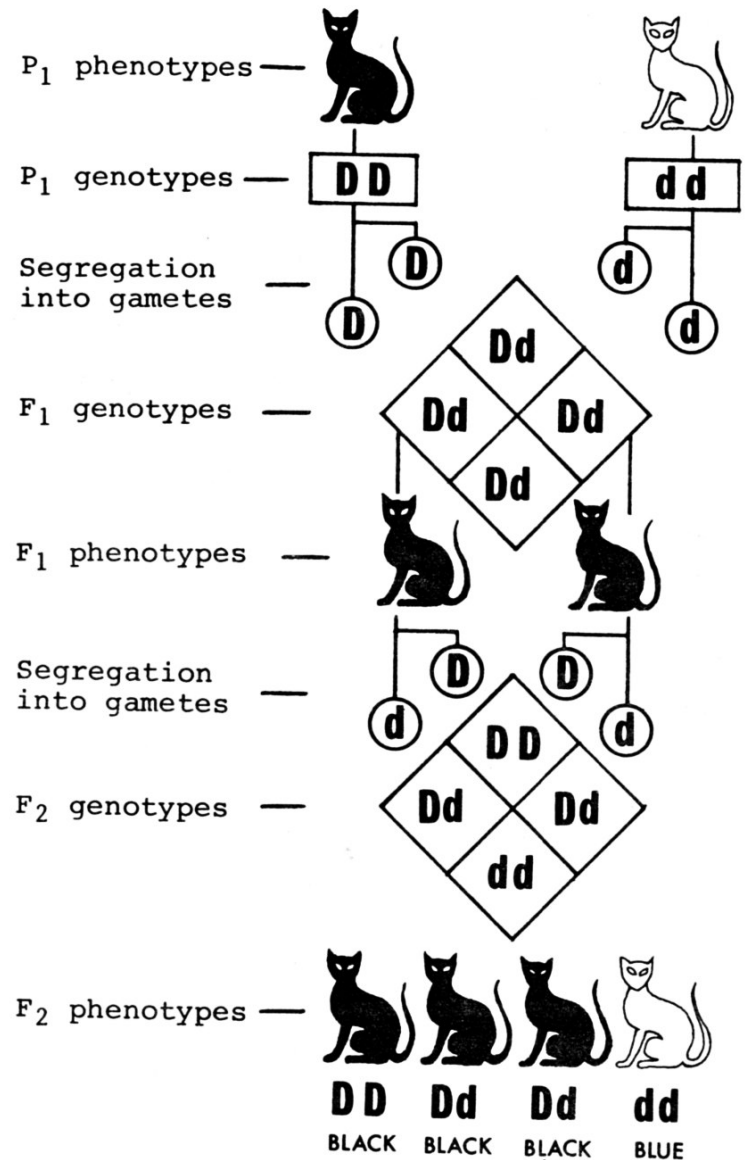

Reconstruction of Mendel's first experiment, as for black and blue cats, and showing how segregation produces a 3:1 ratio of dominant to recessive among the F_2 generation. D is dominant to d which is recessive. Diagram by Malcolm Lauder.



Int. Ch. Minette v. Poelgeest

Cattery van POELGEEST

PERSIANS
CREAM AND
OTHER COLOURS
SIAMESE

LILAC PT. (24C)
CHOCOLATE PT. (24B)

BEST EUROPEAN BLOODLINES
INTERNATIONAL CHAMPION SHOW-CATS
- HEALTHY BROOD QUEENS -

Int. Ch. MINETTE VAN POELGEEST (Blue) and her brother, Int. Pr. MON BLANC V. POELGEEST (White).
Int. Ch. CATTLEYA VAN POELGEEST (Lilac Pt. Best-In-Show) and daughter, CATTLEYA'S MERRY-GO-ROUND VAN POELGEEST (Challenge Cert. & Best Lilac Pt. at 10½ months).

MEVR. J. J. MOORMAN — Witte de Withlaan 1 — Oegstgeest
HOLLAND
Tel. 01710 - 52402

Rex Cornish Kat

IN JUNE, 1973, WE ARE EXPECTING KITTENS FROM



SIRE: INT. CH. HECTOR AF HADSUND (CREAM)
 DAM: SENTRY-TWIX ATHENE, PERFECT, CLEARLY
 DISTINGUISHED TORTOISESHELL & WHITE.
 PURE CORNISH REX BREEDING FROM NANCY
 HARDY, ENGLAND.



FOR SALE: CORNISH REX MALE, HANNIBAL, BORN IN JANUARY, 1973
 SOLID BLUE. EXCELLENT TYPE AND REXING. FOR BREEDING AND
 EXHIBITION. SIRE: INT. CH. HECTOR AF HADSUND.

FANNY ELDEVIG
 Gammel Vartov Vej 23
 2900 Hellerup-Copenhagen
 DENMARK

af Gammel Vartov

gametes in equal proportions---one carrying D and the other carrying d. The chances for any male gamete to fertilise a female gamete similar to itself are equal so that four types of fertilisation are possible.

Genotype Phenotype

1 DD = Black
 2 Dd = Black
 1 dd = Blue
 Ratio 3:1

		Black	
		M	D
Black	F	D	d
	D	DD 1	Dd 2
	d	Dd 3	dd 4

The experiment between black and blue cats shows the method by which a single dominant or recessive characteristic is inherited and the ratios will apply to any matings between black and blue breeds and similarly to any matings between cats with dominant and recessive characteristics.

Since any recessive coloured cat must be homozygous in order to express that colour, the only doubt may be concerning the genotype of the dominant mate. If, by its pedigree, homozygosity is uncertain then its previous breeding records could give the answer.

So the kittens of any blue cat x homozygous black cat are black and the kittens of any cat of recessive characteristic x cat of homozygous dominant characteristic are of the dominant characteristic.

Keeping to the blue x black matings a few examples are given as follows:

1. Blue Persian x homozygous Black Persian = all Black;
2. Blue Smoke x homozygous Black Smoke = all Black Smoke;
3. Blue Chinchilla x homozygous Normal Chinchilla = all Normal Chinchilla;

4. Blue British x homozygous Black British = all Black;
5. Blue Burmese x homozygous Brown Burmese = all Brown;
6. Blue Point Siamese x homozygous Seal Point Siamese = all Seal Point;
7. Blue Tabby x homozygous Brown Tabby = all Brown Tabby.

The above matings are all between cats with either D or d in their genotype as Brown Burmese is black amended by a gene for burmese; Seal Point Siamese is black amended by a gene for siamese; Brown Tabby is black amended by a gene for agouti; Chinchilla is black amended by another, etc.

All the Black, Black Smoke, Normal Chinchilla, Brown Burmese, Seal Point Siamese and Brown Tabby kittens will, of course, be heterozygous for blue.

The kittens of any mating between these cats heterozygous for blue or any one other recessive characteristic will assort in a ratio of three dominant to one recessive and taking the same examples again the results would be as follows:

1. Heterozygous Black Persian x heterozygous Black Persian = 3 Black:1 Blue;
2. Heterozygous Black Smoke x heterozygous Black Smoke = 3 Black Smoke:1 Blue Smoke;
3. Heterozygous Normal Chinchilla x heterozygous Normal Chinchilla = 3 Normal Chinchilla:1 Blue Chinchilla;
4. Heterozygous Black British x heterozygous Black British = 3 Black:1 Blue;
5. Heterozygous Brown Burmese x heterozygous Brown Burmese = 3 Brown:1 Blue;
6. Heterozygous SP Siamese x heterozygous SP Siamese = 3 SP:1 BP;
7. Heterozygous Brown Tabby x heterozygous Brown Tabby = 3 Brown Tabby:1 Blue Tabby.

SOLUTIONS TO PROBLEMS ON PAGE 28 WILL BE GIVEN NEXT ISSUE. STUDY UNIT #4 PRESENTS THE 1:2:1 RATIO.

LETTERS

NEW REX MUTATION?

In your second issue of CAT WORLD there were several fine articles about rex cats. I am a small, new breeder of Cornish rex but just recently I was lucky enough to obtain a curly adult cat from a barn population in Pennsylvania. The cat, Radar, is from a semi-feral line of ASH with no known exposure to registered rex cats. Radar is quite typey ASH but with lovely, thick, soft curls.

Hair samples have been sent to Roy Robinson for examination and evaluation. He reports: "The hair samples reveal that the hairs are typically rexoid. Not of the Devon type but somewhat similar to the Cornish." He recommends experimental crosses to both Devon and Cornish to determine if Radar is indeed a distinctive rex variety. An experimental breeding to ASH has already been made and we are awaiting kittens at this point.

Anyone who is interested in assisting in these first crosses please let me know. I would be happy to hear from anyone who may know of any other "barn" rexes.

Mrs. Mary J. Dunn, 1307 Jeffers Ct.
Towson, Md. 21204

ENJOYS "CAT WORLD"

I am sure this little masterpiece is going to prove its value to those of us whose interest is deep. As a judge, the articles are worth their weight in gold to me.

Grace M. Clute, Corresponding Secy.
Cat Fanciers Federation

MUCH INTEREST IN MAINE COON CATS

We have just sent out our two thousandth packet of materials on Maine Coon Cats. It went to Mrs. Alison Thompson, 22 Alaska St., Roxbury, Mass. 02119. She has been voted an honorary fanciers membership in commemoration of her historic inquiry.

To all who inquire we send a copy of our Newsletter, "The Scratch Sheet", a list of breeders of Maine Coon Cats, copies of codes we have developed for the sale and shipping of kittens, several magazine reprints dealing with the history of the Maine Coon Cat, the Standard and Profile Drawings.

Rodney A. Ljostad, Vice President
Maine Coon Breeders & Fanciers
12 Brook Lane, Port Chester, N.Y.

DEVON REX BREED CLUB FORMS

As of June, 1972, the Devon Rex (Rex Gene II) has been recognized for championship competition in A.C.F.A.

Several Devon Rex owners and breeders have formed an unaffiliated Devon Rex breed club and are attempting to organize a Devon Rex stud book.

Would any person breeding or owning a Devon Rex please write?

We would be happy to answer any questions about the Devon Rex breed.

Anita J. White, 5203 Periwinkle
Austin, Tx. 78745

LOVELY Siamese Cattery



OFFERS AT STUD:
ALL-EASTERN SEAL LYNXPT. '73
← "FUZZLE"
ALL-EASTERN BLUE LYNXPT. '73
"BRUJO"

AND CH. MALES IN RED; CHOC.; LILAC;
ALBINO; WHITE.

ALSO AT STUD: QUINT. CH. ABYSSINIAN

KITTENS IN ALL COLORS; BOTH BREEDS

RD #2, BOX 758, ANNVILLE, PA. 17003
Phone: (717) 867-4275

Stud Book Fanciers Assn.

Membership, including Newsletter:

\$2.00 per year

CFA STUD BOOKS 31 - 94 NOW AVAILABLE
FROM MRS. DICKIE



Unaffiliated

President

Mrs. A. M. Dickie
747 So. Almansor St.
Alhambra, CA 91801

Secretary-Treasurer

Mrs. Warren Wise
1990 20th Avenue
San Francisco, CA 94116

SCINTILLA

SIAMESE

SEAL AND BLUE POINTS OF CLASSIC ENGLISH
PEDIGREE. ALSO A FEW QUALITY TABBY
POINTS (LYNX COLOURPOINT SH)

FOREIGN WHITE

WHITE SHORTHAIRES
SELECTIVELY BRED FOR
DEEP BLUE EYES, SI-
AMESE TYPE AND WITH
THE PREFIX THAT
FOUNDED THE BREED.

ORIENTAL SMOKES, & ORIENTAL PASTELS

IN BLACK, SILVER,
BLUE, COPPER, LAVENDER,
APRICOT, IVORY AND ALL
COLOURS DAPPLE.

ALSO OTHER SIAMESE TYPE SHORTHAIRES IN ALL COLOURS



Patricia
Turner

Tel. Eastbourne 55891

7 BODIAM CRESCENT,
EASTBOURNE, BN 22 9HQ,
ENGLAND

↓ PERUSE & CHOOSE ↓

TO PLACE YOUR ADVERTISEMENT:

Type or print your advertisement on a plain sheet of paper, indicate title under which it is to appear, and mail (with payment in full) to: CAT WORLD, 5395 South Miller St., Littleton, Colorado 80123, U.S.A.

Residents of U.S.A. and countries other than the United Kingdom are requested to pay in U.S. funds. Check or money order should be made payable to CAT WORLD.

UNITED KINGDOM residents may pay in British sterling by cheque or postal order made payable to S.R. Thompson. It is not necessary to obtain U.S. funds.

RATES	Total Cost For 3 Issues	Total Cost For 6 Issues
Up to 25 words	US \$5.00	US \$8.00
	UK £2.00	UK £3.20
Each extra word	US .20¢	US .32¢
	UK 8p	UK 13p

Cat Clubs

TEESSIDE CAT CLUB WELCOMES ALL CAT-LOVERS. REGULAR Meetings and Newsletters. Secretary, 19, Roseberry Drive, Great Ayton, Teesside, TS9 6EQ, ENGLAND a

THE ORIGINAL TURKISH ANGORA SOCIETY INVITES INQUIRIES. Mrs. George Thornton, 2750 S. Jamie Avenue, Tucson, Arizona 85706 USA. Phone: (602) 883-3413/ a

Cats At Stud

COLORPOINT SH. CFA CH. BODANTE UTOPIAN, RED PT. PROVEN. Best NW Red Point, 1973. Straight import lines. 5395 So. Miller St., Littleton, Co. 80123 USA. 303-986-0442. b

HIMALAYAN. GLEN TRAIL GEORDIE. HEAVY-BONE SEAL POINT Himalayan, nice disposition and willing. Joy Allen, 534 Glen Trail, Topanga, Ca. 90290 USA. 213-455-2369 d

CORNISH REX - BLACK SMOKE CFA AND ACFA GRAND CHAMPION Nike Glimmer of Chalonai. Exquisite type, very marcel waved. (See "Gallery" for picture). Linda Wilson, Route 4, Box 128, Liberty, Mo. 64068. USA. 816-781-6808. f

Multiple

CONCHO CATTERY OFFERS SABLE BURMESE WITH EVEN, BARLESS coats and typey Siamese, primarily Blue Points. Top bloodlines, unequaled personality, health guaranteed. Ruth Phillips, 1305 E. Mulberry, Apt. 8, San Antonio, Texas 78209 USA Ph. 512/824-7054 a

COPPLESTONE PERSIANS/HIMALAYANS/BURMESE. HIGH QUALITY show/breeding stock usually for sale. Reasonable prices Also kittens as above. Mrs. W. Bentinck, Sparks Farm, Barkham, Wokingham, Berkshire RG11 4TL ENGLAND a

JASSY'S AND INX CATTERIES--ACA, ACFA, CFA HOME-RAISED Persians and Manx. Any color Persian; Black, Blue, Tabby, Calico Manx. 480 Temple St., Satellite Beach, Fl. 32937 USA. Ph: 305-262-3133 b

RUSSIAN BLUE KITTENS SOON FROM CFA GR.CH. SIRE AND DAM. Extremely light, silver-tipped coats. Typey, affectionate American Shorthairs--Blues, Smokes, related colors. Satin Song Cattery, 915 Valley View Dr., S. Charleston, W. Va. 25309 USA b

LIMMERICK CATTERY: COLOR-BRED CHOCOLATE AND BLUE POINT Siamese; Korats from proven Thai origin; kittens, stud service. The Broadbents, 2801 Nantucket Court, Winston-Salem, North Carolina 27103 USA. 919-768-7173 f

PEARCROFT PERSIANS, BLUE, BROWN TABBY. SIAMESE, LILAC, Bluepoint. British Blues. Kittens from well-known, successful lines. Mrs. Diana Jarrett, Pearcroft, Aston Fields, Ashchurch, Gloucestershire, England. f

KITTENS. MAINE COON OR SIAMESE FROM REGISTERED CHAMPIONS Reasonably priced. Healthy and loving. Pat Garner, 1013 Gardens Rd. SW, Roanoke, Va. 24014 USA. 703-343-2750 e

MINOUI CATTERY: 4 TYPEY PERSIANS, STRAIGHT ENGLISH Import lines--Show: 2 Cream males \$200 and \$300, 2 Blue-Creams \$200 and \$250. Also Manx breeders and show \$150 up. Anna Johann, 1520 S.W. 82nd Circle, Oklahoma City, Okla. 73159 USA. 405-681-7453 e

HAPPY DAYS: ABYSSINIANS, BRITISH BLUES, EGYPTIAN MAUS, Havana Browns, Rex, Russian Blues, Tonkinese. Adults and kittens available for sale from top show parents. Mrs. Mona Day, 18 Pleasantview, Milford, Ohio 45150 USA 513-831-5475 d

ARBAYBI BIRMANS AND BURMESE. HOUSE-REARED KITTENS WITH purr-fect temperaments. Enquiries welcomed. Mrs. Jean Park, 13 Eastmere Road, Wigston Magna, Leicester, England. Telephone: Leicester 884889. c

BRYLOU: HAVE CHINCHILLA AND DEVON REX KITTENS FOR SALE to loving homes only. Enquiries welcome. Mrs. Louvane Stevenson, 9 Park Crescent, Retford, Nottinghamshire, England. Retford 2128. c

COHANA LYNXPOINT/RED ABYSSINIAN/ASH CLASSIC SILVER, queens/stud service/kittens usually available. Graham, R.R.#3, Box 9, Paris Pike, Lexington, Ky. 40505 USA. 606-299-8394 c

HARVARD CATTERY - "THE BEST" IN PERSIANS OR MANX. Kittens for sale from top show cat parents, show/breeding. All colours. Reasonable. Eileen Power, 4371 Harvard Avenue, Montreal 260, Quebec, Canada. Ph: 514-488-6787 c

DOBHRAN CATS. SIAMESE, BURMESE, ABYSSINIANS. TOP quality kittens from prize-winning stock usually available. Burmese at stud. Excellent type, temperament. Patricia Lamb, 41 Blendon Drive, Bexley, England. 01-304-1288 f

Abyssinian

COMPANION CATS. ACCA MEMBER, PET PRIDE APPROVED. TOP-quality Reds--home-raised. \$100 to \$300. Send 50¢ and two 8¢ stamps for "Information Packet." Ms. Pam Black, Route 1, Dover, Ohio 44622 USA. a

FIDDLER'S PIZZI EXPECTING. ABYSSINIAN KITTENS DUE APRIL Gr.Ch. Amon Ra is proud papa. Mrs. George Higgins, 2112 Delcy Dr., Rockford, Ill. 61107 USA. 815-398-6247. d

CARACAL RUDDY ABYSSINIANS, KITTENS FOR SALE NOW, FROM well known bloodlines. Prompt answers to replies. Vet certificate. Katherine Keland, 1425 Valley View Drive, Racine, Wis. USA. 414-639-1425 d

ABYSSINIANS. KITTENS. SIRE: CH. NILE'S SOTER OF PEARL; Dam: Ch. Amulet's Pekit of Pearl. PEARL Cattery, 1808 Meadow Lane, Arlington, Texas 76010 USA. 817-274-4255 d

SI-ABY CLOSING OUT ABYS. RUDDY & RED MALES, QUEENS & kittens. Very reasonable. Also Shaded Silver ASH male. Mary Bolles, 4541 Bluebelle, Memphis, Tn. 38109 USA 901-785-2381 d

CHAT CHALET ABYSSINIANS. RUDDY AND RED KITTENS AVAILABLE for petting/breeding/showing. Excellent bloodlines. Champion Red and Ruddy males at stud. Sherrie and David Witt, 445 South Elmhurst Rd., Mt. Prospect, Il. 60056 USA. 312-259-8257 e

SIGIRIYA ABYSSINIANS--RED AND RUDDY KITTENS FROM CHAMPIONS for sale. Best Litter In Show, May, 1973. Mr. Joergen Andersen, Eckersbergsveu 31, OK-5000 Odense, Denmark. f

American SH

CHIN HILLS - NEW LITTERS BORN MARCH 1973. CHAMPION sired torties, blue tabbies, blue-cream and blue-cream torby females. Also white Turkish Angoras. The Horensteins, P.O. Box 3, Ojus Station, Miami, Fla. 33163 USA 305-931-5622 e

AMERICAN SH (CONTD.)

SHERETA. CFA BLUE/BLUECREAM. EXCELLENT DISPOSITION. IN-
quiries answered promptly. Greta Spencer, 132 Oakwood
Rd., Charleston, W.V. 25314 USA. Phone: 304-342-6424 a

Birman

SMOKEYHILL BIRMANS AND HIMALAYANS. TOP SHOW KITTENS
occasionally available from my Champion queens and
studs. Miss Brown, Castle Lea, Crete Road West, Folke-
stone, Kent, ENGLAND. a

MASK RIDER BIRMANS--LOVELY KITTENS AND YOUNG ADULTS
from choice bloodlines--Imported and American stock.
Fay Mosier, P.O.Box 1025, Homestead, Florida 33030 a

British Shorthairs

KALICO BSH'S. BLUES, CREAMS, BLUE-CREAMS & BLACKS. BLUE
kits available now sired by Triple Gr. Ch. Broadweir
Union Jack of Kalico (Imp.) Other colors soon. Mrs.
Lois Varey, Vermette P.O., Manitoba, Canada ROG2WO
204-253-1964 e

Burmese

ARAKAN--BEAUTIFUL, CHUNKY, BOUNCY, BARLESS, BROWN, BABY
Burms. Kittens, stud service. Joanne - Gary Lucas, 5925
Brookside, Kansas City, Mo. 64113 USA. Phone: (816)
363-4857. c

BURMESE--REASONABLE PRICES. SABLES ONLY. CHAMPION MALES
at stud. Kittens occasionally. Pet/show quality. Inqui-
ries invited, Deals, 5 Lazee Trail, Houston, Tx. 77024
USA. 713-461-2436. c

ILUSKASS BURMESE. THE CATTERY IN AN OLD ENGLISH GARDEN
usually has kittens available, all colours including
glamorous Cream and Reds. Bred from Champion stock.
Hygienically and lovingly reared. Coloured photographs
and pedigrees willingly forwarded. Apply Mrs. B.Procter
"Iluskass" Hurst Lane, Egham, Surrey, England. c

BURMA MATAGOT SABLE BURMESE KITTENS. MANY CFA GRAND
Champions in background. Born May 4th. Available for
new show season. Nadine Buell, 1601 Redwood St.,
Vallejo, Calif. 94590 USA. Phone: 707-642-3756. f

TOPAZ CATTERY: SABLE BURMESE SHOW KITTENS AVAILABLE
from Gr. Champions. Stud service. Experienced shippers
domestic and intercontinental. Louis & Barbara Hart,
117 W. S. College St., Yellow Springs, Ohio 45387 USA.
Ph. 513-767-7769. f

TRAIMENE BURMESE: BLUE, SABLE KITTENS FROM CHAMPIONS
Will reserve show/breeder/pet. Guaranteed health,
temperament. Sable stud service. Bagshaw, 85 Rockport
St., Marshfield, Mass. 02050 USA. Ph. 617-837-0218 b

AH-SEE CATTERY. SABLE BURMESE FINEST BLOODLINES. KITTENS
proven adults and stud service available. Inquiries
promptly answered. 503 S. Carroll, Michigan City, Ind.
46360 USA. 219-872-8030 d

Colorpoint SH

COLORPOINTS--KITTENS COMING SOON. CFA CH. TORTIE--5TH
Best of the Best at Santa Monica. GATO DE ORO. Mrs. Joy
A. Pierce, 664 Tulane Dr., Santa Clara, Ca. 95051 USA d

BEAUTIFUL, TYPEY RED POINT KITTENS. FINE PEDIGREES. OF
Bodante/Solitaire stock. Males/females. Also lovely
Seal Tortie kitten and 18-month-old Red Pt. female.
5395 S.Miller St., Littleton, Co. USA 303-986-0442 d

SHOW QUALITY RED, TORTI, & LILAC PT. SIAMESE. GR.CH.
Don Jose, CFA NW Region Best Red Color Pt. 71-72, at
stud. Kittens ready now. Pictures and pedigree on re-
quest. HU-MAN Cats, 1926 W. 6255 S., Salt Lake City, Ut
84118 USA. Ph. 801/298-5280 d

Havana Brown

CHARMET'S CHARMING HAVANAS, ADORABLE BROWN BEAUTIES FOR
show or pets. Gentle "people" cats, they love us. CHAR-
MET Cattery, Avis Coffman, 7624 Travelite, Canutillo,
Tx. 79835 USA d

HALLMARQUE HAVANA BROWNS: SPRING AND SUMMER KITTENS
from consistent breed winners and show finalists. Mr./
Mrs. Marc Hines, P.O. Box 534, Orange Park, Fl. 32073
USA. 904-264-6613 e

TAWNEE/EENWAT: QUEENS, STUDS, KITTENS. ALL SOUTHERN,
Multiple champion and champion stock. ACFA, CFA. Out-
standing color, temperament. 16921 NW 20th Ave., Opa
Locka, Fl. 33054. e

TOBACCO RD. OUTSTANDING HAVANAS WITH CHOCOLATE COATS.
Top bloodlines. Cats, kittens. Limited stud service.
Edward Windham, 4422 Temecula St., San Diego, Ca. 92107
USA. 714-225-1532. b

Himalayan

PITTMAN'S HIMALAYANS, KITTENS AND CATS, SEAL POINT,
Blue Point, Lilac Point, Choc. Points, Bluecream Points
Flame Points, Tortie Points and hybrids. Stud service.
1430 East Bastanchury Road, Fullerton, California 92635
USA. 714-8719590 or 5295521 and 213-6971762. a

BONNIVIER - EXCEPTIONAL HIMALAYANS. SEAL, BLUE, FLAME,
Tortie, Blue-Cream Points. Seal, Blue, Flame Point stud
service. Bonnie Vierregger, 11664 Pierce St., Omaha,
Nebr. 68144 USA. Phone: 402-333-7944 a

ROYAL ROW HIMALAYANS--HOME OF "TROUBADOUR OF ROYAL ROW"
A.A. Seal Point Male of Color "72". Quality kittens--
Seal, Blue & Tortie Point. Choc & Lilac Stud Service.
P.O. Box 128, Bellflower, Ca. 90706 USA Ph.213-867-2301

JEANINE HIMALAYANS - THE DIFFERENT ONE. FINE QUALITY
kittens & cats. Lou C. Fur, Gr.Ch. Littlest Angel's
black son at stud. Gray, 36 Emerald Court, Ocala, Fl.
32670 USA e

HAROBED HIMALAYANS, HOME OF MANY AA, AE AND CFA ALL
Star winners. Kittens, adults, stud service. Rose Levy
Box 213, Plainview, L.I., N.Y. 11803 USA. Ph. 516-931-
0924. b

CAT LORE - HIMALAYANS, PERSIANS, CHOCOLATE/LILAC LONG-
hairs. All Himalayan Point colors and hybrids. Solid/
Particolor Persians. Top breeding and show stock. Sat-
isfaction guaranteed. Detailed photos. Laurie Stevens,
1452 N. Latrobe, Chicago, Ill. 60651 USA. 312-622-1030 b

YETI'S CATTERY, REG. CFA, ACFA. HIMALAYANS, BLUES &
Seals. Top bloodlines. Kittens and boarding. Dub and
Marie Stringfield, P.O.Box 831, Buras, La. 70041. Home
raised. a

GLEN TRAIL, PERSIAN TYPE, SEAL OR BLUE POINT KITTENS
from champion parents of the Chestermere line. Send for
list. P.O.Box 171, Topanga, California 90290 USA. d

BADI HIMALAYANS - FOR SALE 2 SEALPT. MALES, 2 CP MALES,
1 black hybrid male. Stud service by reservation,
please. Grand Champion & Champion sired. Heidi Noddin,
105 Young Blvd., Universal City, Texas 78148 USA. f

Korat

KORATS - THAI-CHI - PROVEN THAI ANCESTRY - GRAND CHAMP-
ion bloodlines - CFA-KCFA. Scotte Rabold, 1234 Cumber-
land Avenue, Dayton, Ohio 45406 USA. 513-278-7142. c

Lavender Foreign SH

TAWNEE/EENWAT: SUPERLATIVE LAVENDERS. EXTREME TYPE,
gorgeous color, fantastic dispositions. 16921 NW 20th
Ave., Opa Locka, Fl. 33054 USA b

Leopard Cat

BOTTLEFED, HAND-RAISED, CFA-REGD. LEOPARD CAT KITTENS.
Distinguished, rare, spotted wild cats. Ready for new
homes March 1. Mary Bolles, 4541 Bluebelle, Memphis,
Tn. 38109 USA. 901-785-2381 d

Maine Coon

NORWYNDE MAINE COONS. SHOW/BREEDING/PET. TOP BLOODLINES
Bred for disposition/type. Tabbies, parti-colors, sol-
ids. Spring/Fall. Ph. 201-694-9248. Lillias Vanderhoff,
21 Jacksonville Rd., Pequannock, N.J. 07440 USA c

LET US TELL YOU ABOUT THESE FASCINATING CATS. WRITE:
Maine Coon Breeders And Fanciers Association, Ms. Patricia
Morrow, Corresponding Secretary, P.O. Box 68,
Tolland, Conn. 06084. c

NOTE TO "PERUSE & CHOOSE" ADVERTISERS



There is no charge for name of country in address.

Manx

BRIGADOON CATTERY--MANX ONLY. ACFA AND CFA REGISTERED. Show/breeding/pet stock; Black and Brown Mackerel Tabby Rt. 6, Box 109-C, Austin, Tx. 78746 USA. 512-264-1825. a

VENDA MANX. THE MAN'S CAT WOMEN LOVE. TOP SHOW/BREEDERS/pets. Reduced prices to those who will alter. Martha Jones, 410 N. Rapp Road, Talent, Oregon 97540 USA Phone: 503-535-2935 a

Persian

CATSPURR CREAM PERSIANS. PET PRIDE APPROVED. CFA. GR.CH stud service. Home-raised kittens--pet/breed/show. 1521 Larkfield Lane, Charlotte, N.C. 28210 USA a

CHINCHILLAS & HIMALAYAN COLOURPOINTS ARE OUR SPECIALTY. Kittens from "Best In Show" Champion queens by Champion studs sometimes for sale to loving homes. Marilyn Woodend, The Nook, Ninebanks, Whitfield Hexham, North-umberland, ENGLAND a

ZELANDO OFFERING AFFECTIONATE, HOUSE-RAISED, ACFA-CFA kittens, breeders, Grand Ch. backgrounds. Top bloodlines. Blues, Smokes, Cameos, Reds. 118 Hilltop Drive, Talent, Or. 97540 USA. 503-535-4115 a

BEAUTIFUL BARWELL PALE CREAM PERSIAN KITTENS. EXCELLENT pedigree, well grown, good type, fabulous coats, deep amber eyes, very affectionate. Only to loving homes. Phyllis Fawell, Broomfield Corner, Broomfield Park, Sunningdale, Ascot, Berkshire, ENGLAND a

MI-DE'S TOP MIDWEST BLOODLINES. BLACKS, REDS, BLUES, Torties, Silvers and Seal Point Himalayans. Kittens available. Excellent disposition. Raised with children and dogs. 206-494-4068 a

DAWN-DEE PERSIANS--QUALITY BLOODLINES. SOLID/PARTICOLOR/Cameo. Grand & Champion proven female available. Mr./Mrs. Jack Miller, 4748 W. Clarendon, Phoenix, Az. 85031 USA. 602-272-1971. b

MINNEWASKA CATTERY--BLUES, BLUE CREAMS, CREAMS, WHITES. Stocky bodies, small ears. Mrs. Roy Vegoe, Glenwood, Mn 56334. Phone: 612-634-3137. b

SILVER WILLOW CATTERY. SPECIALIZING IN CHAMPION-SIRED Silver Tabbies. Available soon: Grand Champion-sired Shaded Silver kittens, Walnut Hill bloodlines. Lucy Kizzier, 9353 Harney St., Omaha, Neb. 68114 USA. 402-393-4086. b

BETSY-BEE PERSIANS FROM CHAROE, K'LANE, BATTOHADI, Stonybrook and Castilia lines. Kittens and cats. Stud service to approved queens. Betsy Boyer, 227 N. Yale Ave., Villa Park, Il. 60181 USA. 312-279-8955 b

CARAJA CATTERY - PET PRIDE APPROVED. SHOW/BREEDER BLACK White, Cameo, Cream kittens. Available. \$125 and up. Excellent bloodlines and good dispositions. Suzanne Mutz, P.O.Box 75313, Oklahoma City, Okla. 73107 USA 405-424-3383 d

BEAUTIFUL RED PERSIAN MALES, 5 MONTHS TO TWO YEARS! From Grand Champion stock. Must see to appreciate. Mrs. C.E. Cruson, 1610 North Cleveland Ave., Loveland, Colo. 80537 USA. Phone 667-3109 d

INTRODUCING KEVINGTON KATTERY, THE COMING NAME IN QUALITY Persians. Finest bloodlines, all colors, typey tabbies. Kathy Cash, 23644 Martha St., Woodland Hills, Ca. 91364 USA. 213-883-1933 d

PINK MOUNTAIN: EXQUISITE SHOW KITTENS. CAMEOS, SOLIDS, Torties. Araho/Azulita/Silva-Wyde/Bloemhill/Zoda. Imports: Beamsley/Pensford/Widdington. Connie Curtin, 6243 E. Monterosa, Scottsdale, Arizona 85251 USA d

GOLDAMIST. CFA. ACFA. PET PRIDE APPROVED. BLUES/BLACKS/Creams/Particolors. Kittens/Stud Service. Mrs. Evelyn Gold, P.O. Box 3445, Cocoa, Fla. 32922. 305-636-0085. Inquiries answered promptly. b

DAISYFIELD OFFERS RED TABBIES. SUPERLATIVE COLOR AND markings. Gentle dispositions. Carefully planned breeding program combining Elco, Bloemhill, Daisyfield lines Truly competitive in today's show ring. 2211 Melrose, Rockford, Ill. 61103 USA. 815-968-8411 e

BE-RU SILVERS, PET PRIDE APPROVED. SHOW/BREEDER/PET. Stud service. Lovable kittens from Grand Champion, Champion stock. Top bloodlines. Mrs. Robert Barrett, 944 Paularino, Costa Mesa, Calif. 92626 USA. 714-540-6985 c

DAVIRO: TOP QUALITY KITTENS/ADULTS IN SOLID, SMOKE, Cameo, Cameo Recessives. Finest bloodlines. Fairly priced. Pet Pride Approved. Mrs. David Dieter, Oronoco, Minn. 55960 USA. Tel. 507-367-4705. c

LIN-LEA - KITTENS FROM OCTUPLE GRAND CHAMPION "ZEUS", Sextuple Ch. "John Henry". See ads in Cats/CFA Year-books. Judy Beery, 1944 Atlin, Duarte, Ca. 91010 USA 213-368-5607 c

PERSIANS BY JO-LE. CFA GR.CH. STUD SERVICE. SOLIDS AND Parti-colors. Breeding and show quality. 225 Hampton Rd. Syracuse, New York USA. Ph. 315-474-2138 c

MAGI-PURR KITTENS, CHAMPION SIRE, CFA/ACFA SHADED Silver/Chinchilla, lovingly home-raised. Show curtains, Kitty bibs. Melinda Gregory, 2050 Stevely, Long Beach, Calif. 90815 USA. 213-431-0268 evenings. c

7 OAKS PERSIANS - REDS, RED TABBIES, TORTIES. OTHER colors occasionally. Phone 315-458-0722. 122 Ford Drive, No. Syracuse, N.Y. 13212 USA c

BIRCH HILL--REDUCING CAMEO BREEDERS--RED SMOKES, REDS, Shaded. Solids--Blue male, B.E. and O.E. White kittens. Betty Vogt, 177 Apollo Dr., Rochester, N.Y. 14626 USA. f

RUFFHAUS SILVERS. QUALITY COLORBRED KITTENS FROM CASHmere, Delphi, Silver Dawn, Walnut Hill bloodlines. Photos, pedigree sketches on request. 11A Brookside Ave., Bellport, New York 11713 USA. 516-286-3728 f

SUZANNE PERSIANS - BLACKS AND COLORBRED SILVERS, SOME Blues and CEWS. Black CFA Gr.Ch. Ra-Le Muffin's Shadow of Suzanne (GLR 10th Best Cat) at stud to approved queens. Show kittens usually available. Suzanne Schabel, 44 Briggs Avenue, Fairport, N.Y. 14450 USA Ph.: 716-377-5334. f

MELITA CATTERY, HOME OF SWEET PERSIANS. BLACK, SILVER, White, Blue, Smoke. Stud service. Ethel Miller, 310 Monterey St., Vallejo, Ca. 94590 USA. 707-644-6176 e

KIT-KAT TOWN PERSIANS--ALL SOLID COLORS, TORTIES, BLUE-Creams, Smokes, Cameos, Bi-Colors, Calicos. Stud service. Judy Beitzel, 638 Childs Ave., Drexel Hill, Pa. USA. 215-CL9-2273 or 215-MA2-0742 e

SURFSIDE PERSIANS, SOLIDS, PARTICOLORS AND SMOKES. Breeder kittens available. Reservations taken on show quality. Ralph & Sue Stevens, P.O. Box 112, Mentor, Ohio 44060 USA e

Rex - Cornish

ONLY GENE ONE REX BEING BRED BY ZUREIQA CORNISH REX IN country surroundings. Strong healthy kittens available later on. Mrs. Hamilton, Haskers, Westleton, Saxmundham Suffolk, ENGLAND a

KENI KATZ. KITTENS FROM OUR CFA CHAMPIONS--GRANDS/Regional/National winners available by reservation. Most colors. Pet Pride Approved. Satisfaction guaranteed. Inquiries answered. Ed and Cynthia Dyer, Rt. #1, Black Mountain, North Carolina 28711 USA. 704-669-8355 b

RIAU-ARCH CATTERY. WEST AUSTRALIA'S HOME OF THE CURLIES Self colours and Torties available now. J. & N.F. Bullcock, 11 Regan St., Coolbellup, West Australia 6163 f

BODANTE BLACK REX KITTENS. GRAND CHAMPION SIRE & DAM. Rodell/Anglo-Tex/Som Chai/Annelida. Born April, 1973. 5395 S. Miller, Littleton, Co. 80123 USA. 303-986-0442 f

ADORABLE RED CORNISH REX MALE KITTENS, GR. CH. SIRE. Fine import bloodlines. Anglo-Tex Cattery, 4909 Tomahawk Trail, Austin, Tx. 78745 USA. 512-444-7346 d

Russian Blue

LUV CATTERY: TOP AMERICAN AND EUROPEAN BLOODLINES. Kittens from award-winning parents. Also Persians and Himalayans. Janet Ritter, 7073 Bestview, Cincinnati, Ohio 45230 USA. 513-231-8964 d

RUSSIAN BLUE (CONTD.)

BLUE SANDS - FIRST LITTER SYNEVA-CARMAC LINES OFFERS pet, breeding, show quality kittens. Excellent type and dispositions. 3138 39th Place, Albuquerque, N.M. 87116 USA. 505-268-9756. f

DAYTIME PRESENTS LOVEABLE, SUPER FRIENDLY KITTENS FROM a winning combination of Velva/Hy-Line, Flo-Mar/Dunloe bloodlines. Grand Champion sired. Candy Craig, 10447-3 Larwin Ave., Chatsworth, Ca. 91311 USA. 213-341-4461 e

BLUEGENES CATTERY. QUALITY RUSSIAN BLUES FROM EXCELLENT bloodlines. Kittens usually available. CFA-ACFA registered. Judith Kethley, 533 Elgin, Forest Park, Illinois 60130. Phone 312-771-5589 b

SYNEVA CATTERY--RUSSIAN BLUES FROM GRAND CHAMPION BLOOD lines. Stud available. We welcome inquiries. The Kirsch's, 28030 Natoma Rd., Los Altos Hills, Ca. 94022 USA. 415-948-6365. b

Self - Longhair

PITTMAN'S, KITTENS AND CATS, THE NEWEST LONGHAIR COLORS Deep Chestnut Brown with Orange Eyes and Light Lilac with yellow eyes. Some carry the Himalayan pattern. Truly a lovely cat to own. Elinor Pittman, 1430 East Bastanchury Road, Fullerton, California 92635 USA. 714-8719590 or 5295521 and 213-6971762 a

Siamese

FANCICATS - QUALITY KITTENS/ADULTS. SHOW/BREEDER/PET. Outstanding male Champion for sale. At stud Triple Champion Fancicat's Corcoran. Clare Braun, 406 Fairmount, Philadelphia, Pa. 19123 USA. Also Burmese. a

SAMOW CATTERY - SIAMESE - SPECIALIZING IN LYNX POINTS. Seal, Blue, Chocolate & Frost kittens also available. Lynx & Seal Points at stud. All enquiries answered. Irma Castle, 362 Mapleview Drive, Winnipeg, Manitoba R2P OK3 CANADA. Phone: 204-338-8677 a

SYLBA SIAMESE. STUD CHAMPION ELBARAKA TROPHIMUS. REGD. 32A Red Pt. Sire Champion Siepoo Storm. S.P. Kittens from Champion-sired Queens. Prue Critchley, Park Farm, Barton-Under-Needwood, Staffs. ENGLAND. Phone: 3113 a

MARKYN CATTERY - SPECIALIZING IN FINE LILAC & CHOCOLATE Point Siamese. Stud service to excellent Siamese and Russian Blue males. Kittens and Boarding. Rockland, Massachusetts USA. 617-878-4401 a

DARLING SIAMESE. ALL COLOURS. CHAMPION STOCK KITTENS usually available. Red/Tortie Point specialist. References required. Mrs. I.M. George, 19 Larchfield Street, Darlington, Co. Durham, England. Phone 66630. c

OPHIR - FINE SEALS AND BLUES. BLACK BART, ZAPATA, BLUE Cavalier and Mr. B in one generation. Mary Lou Nolan, 10368 Carrollwood Lane, Tampa, Fl. 33618 USA. 813-935-6321. c

BEV-LEN SIAMESE CATTERY - PET PRIDE APPROVED. CHAMPION bred/sired kittens, Lilac/Choc. Occasionally Blue/Seal points. Mrs. Leonard 'Bev' Reedy, 962 No. McClellan Ave Decatur, Ill. 62522 USA. f

FOR SALE: ADULT BREEDERS--MOSTLY CHAMPIONS--IN LYNX, Albino, Red, Tortie, Lilac, Blue. Also kittens. Lovely Cattery, RD#2, Box 758, Annville, Penna. 17003 USA 717-867-4275 f

AT STUD: TABBY POINT SIAMESE, CHAMPION CHOSEN PHANTOM Fella. Also S.P. Birman Shaminka Houdini, Himalayan Meonvale Morgan. Kittens for sale from time to time include Burmese, Siamese, Birman, Rex & Colour Points. Mrs. Jo Cresswell, Bouladuff, Marine Road, Greystones, Co. Wicklow, IRELAND a

LEGOULLON'S SIAMESE - ALL COLORS - STUD SERVICE. TOP winning lines, Jen-Kins, Maloja, Jo-San, Tap Toe, Pure English - Makhanda, others. Ann LeGoullon, 19403 Vineyard Lane, Saratoga, Ca. 95070 USA. Ph: 408-257-2456 a

SHERETA. CFA. EXCELLENT CHAMPION BLOODLINES. BLUE/SEAL. Blue Stud. Inquiries answered promptly. Greta Spencer, 132 Oakwood Road, Charleston, W.V. 25314 USA. Phone 304-342-6424 a

SHARA - PERSONALITY PLUS TOP GRAND CHAMPION BLOODLINES. Behind Shara are the best of Thaibok, Catana, Singa, Gaidon, Karnak, Maloja. Kapilian, 39 Edi, Plainview, N.Y. USA. 516-WE5-3439. b

TSIN THAI SIAMESE--KITTENS & STUD SERVICE--DINAPOLI & English bloodlines. Very affectionate. Mrs. P.E. Pilcher Box 4, Site 3, RR#5, Calgary, Alberta CANADA T2P 2G6 b

VINDABONA. CHOCOLATE, LILAC & SEALPOINT KITTENS. SHOW, breeder and pet quality. San-Toi, Catana and import bloodlines. Trudy Hoffman, 1549 W. Indianola, Phoenix, Ariz. 85015 USA. b

FOTHERINGAY: SEAL, BLUE, CHOCOLATE & LILACPOINT SIAMESE Also Rex. Tom and Elaine Keen, 845 Walnut St., Milford, Ohio 45150 USA. 513-831-5297 e

VINDABONA: LILAC POINT MALE, 10 MONTHS, PROVEN. SELL or trade. Both parents San Toi-Catana bloodlines. Trudy Hoffman, 1549 W. Indianola, Phoenix, Az. 85015 USA 602-264-3590. e

STONEYCLOUD SIAMESE ARE WINNING AT SHOWS IN ENGLAND, Canada and U.S.A.! Kittens born early December now available. Seal Lynxpoints, Sealpoints, Chocolatepoints Typey and affectionate. Mr. R. Wiltshire, 61 Beechwood Road, Luton, Beds. ENGLAND d

THE HOUSE OF CHUSAN - SPECIALIZING IN SEAL & CHOCOLATE Points - Welcome and wish every success to "Cat World". Ron & Rita Care, 118 Cippenham Lane, Slough, Bucks. ENGLAND. Phone: Slough 20280 d

TI SONG SEALPOINT, BLUEPOINT SIAMESE KITTENS FROM CHAMPION and Grand Champion cats: Maloja, Hutzler, LeShin-Wieler, and Grand Champion English lines. Judy Ramsey, 1200 W. Pine St., Lantana, Fl. 33462 USA. 305-582-6254 d

BEV-LEN CATTERY OFFERS LILAC PT. KITTENS BORN 12-1-72. Proven Lilac stud for sale. Champion lines. Mrs. Leonard "Bev" Reedy, 962 N. McClellan Ave., Decatur, Ill. 62522 USA d

BAYARD SIAMESE, WELL-BRED SEAL AND LYNX POINTS occasionally available to recommended homes only. Mrs. K. Strunin, 44 Beaulieu Avenue, Sydenham, London S.E.26 6PP ENGLAND. f

RED & SEAL-TORTIE POINT KITTENS SIRE BY CFA NW REGL. Red CP SH, Bodante Utopian, x imported queens. Also young Red Pt. queen. CFA/ACFA. Red & Lynx Pt. stud service. 5395 S. Miller, Littleton, Co. 80123 USA. f

KITTEL KIT: ALL COLORS, MALOJA/JEN-KINS LINES. TR.GR.CH Jen-Kin's Rebel of Catana at stud. J. McMillen/R. Kittilstvedt, 5652 Calmor Ave. #2, San Jose, Calif. 95123 USA. Ph: 408-578-0776. d

Turkish Angora

TURKISH ANGORAS, PURE NATURAL BREED FROM ANKARA ZOO imports. Thornton's Desert Cattery, 2750 S. Jamie Ave., Tucson, Arizona 85706 USA. Phone: (602) 883-3413 a

PITNEY FARM HAS ANGORA KITTENS DUE APRIL FROM R.M. QUAD Ch. Yansi of Pitney Farm. Jo Anne Gilbertson, Route 1, Cottage Grove, Wisc. 53527 USA e

CFA'S ONLY BREED CLUB DEVOTED EXCLUSIVELY TO TURKISH Angoras. For membership, kitten/stud registrars, breed information: National Turkish Angora Cat Club, Woodbine, Md. 21797 USA. 301-795-1367. b

MEERA TURKISH ANGORAS, PUREBRED KITTENS BY RESERVATION. Stud service to approved queens. Pet Pride Approved. Inquiries welcomed. Joan Kapetanakis, 1 Edwards St., Roslyn Hts., N.Y. 11577 USA c

TURKISH ANGORA KITTENS FROM ALL AMERICAN QNT. CHAMPS. Champs & impts. Lovely disposition and looks. Inquiries welcome. Tai-Phoon Cattery, RD 1, Box 365, Van Etten, NY 14889 USA c

WANTED

CFA YEARBOOK EDITIONS FOR YEARS PRECEDING 1968. OLD CAT books with history of the fancy everywhere, development of breeds, etc. Write giving price wanted to Pauline Thompson, 5395 S. Miller St., Littleton, Co. 80123 USA

Worldwide Winners

JAN. 6-7, 1973, CANTON, OHIO (CFA), CANTON HALL OF FAME C.C.
Marked catalog sent by Marlene Luyster.

AB: JEANIE MCPHEE'S BEST CAT--# 240A. POETL'S ST ASH M APACHE CHIEF MATEO; 2BC--#253 M/M H.Kemps' Bur m Kemlen Kepwe; 3BC--#217 E.Prather's BC Per f Shennen's Luv Bug of Prim-Pet; 4BC--M.Hoag's Blu Sm m Per Castilia V.I.C. of Nor-Mont; 5BC--#133 M.Hoag's CEW Per f Castilia Pekoe Doll of Nor-Mont; BK--M.Hoag's Nor-Mont Pekoe's Little Darling; BP--#349 B.Collins' BEW Mx f Kittrik's Bon-Angel of Wila-Blite. AB: WM. THOMPSON'S BEST CAT--#183 S.GRAZIANI'S SH SIL PER M JUBILEE'S BEAUREGARD; 2BC--#240; 3BC--#319 Dr/M W.Selfs' SP Sia f Thai-Mao's Shasta Daisy; 4BC--L.Grussell's BP Him f Hima Tab Miss Muffet; 5BC--#265 J.Sutherland's Bur f Colony's Susannah of Brown Watch; BK--E.Prather's Red Per f Rene Punkin Puss of Prim Pet; BP--#340 G.Roberts' Chin f Ruthsboros Lorlei of Happy Days. LH SP: RICHARD KOEPP'S BEST CAT--#133; 2BC--#183 3BC--M.Hoag's Rd Per m Castilia Red Treasure; 4BC--#217; 5BC--M/M R.Russell's Blk Per m Prim-Pet's Midnight Cowboy; BK--W.Kelly's Chin Per f Marlboro Meringue; BP--#340. SH SP: RICHARD KOEPP'S BEST CAT--#240; 2BC--M.McIntyre's Svr.Mk Tby ASH Jellia Jamb of Saren-Del; 3BC--#265; 4BC--#319; 5BC--G.Sellars' Kor m Tru-Lu's Thi-Thawee; BK--R.Quader/G.Litts' ST ASH m Kevron's Han Som Man; BP--#349. LH SP: MERCEDIER GOODWIN'S BEST CAT--#133; 2BC--#183; 3BC--T.Perry's Tor Per f Perryacre Lady Fan Tan; 4BC--Ms.E.Miller's Blu Per f Solon Annee Lauree; 5BC--D.Baker's Bn Tby Per m Your Pets' Lem-Mee BK--Ms.W.Stephens' CEW Per m Cyndi-Kits Meteorite; BP--#340. SH SP: KAY MCQUILLEN'S BEST CAT--#319; 2BC--#253; 3BC--#240; 4BC--D/C Wards' RB m Meri-Rose Nicholoi; 5BC--L.Dzbanski's BP Sia f Tap-Toe Daneta; BK--M.Chandler's Bur f Choc-Alure's Cara; BP--#349.

FEB. 11, 1973, KINGS LYNN, ENGLAND (GCCF) SUFFOLK & NORFOLK

No B-I-S wins. Following are some of the Best of Breed wins taken from a complete list sent by Mrs. E.E. Arnold, Mgr. LH Adults: Blk F Hardendale Penny Black; CEW m Finchfield Michael; Blu m Peela Ceasar; Cm m Norvician Fantastic; BC f Blyth Pollyanna; Sm m Int Ch Sonata Adagio; Chin f Pasha Sheba Savoirfaire; T&W Pathfinders Forgetmenot; Him m Ming-chiu Ghunti; Bi-C m Toppatou Jules; Bi-C f Pathfinders Red Flame; SH Adults: Blk f Shellwood Valentino; Cm f Claire de Lune; Blu m Ambercloud Mostyn; BC f Ch Broadweir Twilight; ST m Bonnymuir Fergus; Tor f Pathfinders Brownie; Sp m Zephyr Achilles; Bi-C f Pathfinders Stella; Rdy Aby f Burtenashan Sokota; Bn Bur Kalos Castor m; Blu Bur f Ramree Hasinah Hav f Southview Duakali; Cor Rex f Lohteyn Traveller's Joy; Dev Rx f Cosmic Tiger Flower; Best Siamese Adults: SP f Quintral Tapatuo; BP f Chalmi Takua; LP m Rantree Sawat; Tby P m Kayou Lenord

MAR. 10-11, 1973, (CFA), ATLANTA, GA., ATLANTA PHOENIX CAT SOCIETY. 141 Exhibitors, 278 Entries. Report submitted by Joe Wheeler.

AB: ADAM FRECOWSKI'S BEST CAT--S.KARR'S SP SIA F KARNAK ARRIBA; 2BC--A. Poeltl's ST ASH m Apache Chief Mateo; 3BC--C.Milwain/L.Swope's Blk Per m Misty Mornin' Marty; 4BC--L. Willwerth/D.Bandy's Blu Per f Lowlands Latecia of Kittrik; 5BC--J.Batchelor's Burm m Tok-Lat's Little Awful Arnie; BK--O.Hollingshead's Blu Per f Flambeau's Blue Fable; BP--E/C Brown's OEW Per S J.B. Showpiece of Jo-Ni AB: VIRGINIA WOLFE'S BEST CAT--APACHE CHIEF MATEO; 2BC--Karnak Arriba; 3BC--Misty Mornin' Marty; 4BC--M.McIntyre's SMkTb ASH f Jellia Jamb of Saren-Del; 5BC--Tok-Lat's Little Awful Arnie; BK--W.Barrer's SMkTb ASH f Barrer Mandy; BP--J.B. Showpiece of Jo-Ni SH--STAN BARNABY'S BEST CAT--KARNAK ARRIBA; 2BC--Apache Chief Mateo; 3BC--Tok-Lat's Little Awful Arnie; 4BC--Jellia Jamb of Saren-Del; 5BC--D/C Sacks' BP Sia f Felitan Argentia of White Acre; BK--J/J Kethley's RB f Bluegenes Caprice; BP--W/D Cummings' Burm S Phi Line Libra of Kaos LH--STAN BARNABY'S BEST CAT--MISTY MORNIN' MARTY; 2BC--Lowlands Latecia of Kittrik; 3BC--J.Ferguson's SS Per f Tania Yatisha of Feri-Purrs; 4BC--J/J Rambo's Cr Per m Justincase Jo Jo of Rambo; 5BC--K. Morris' SS Per m Kitza Kalif of Starlet Manor; BK--C/S Mullins' Cr Per m Astro Acapulco Gold; BP--J B Showpiece of Jo-Ni SH: LILLIAN JACKSON'S BEST CAT--KARNAK ARRIBA; 2BC--H.Smith's Burm f Chinquapin's Puff 'N' Stuff; 3BC--D. La Via's Rdy Aby m Wohl-Rabe's Abdel Simbel of Andor; 4BC--J. Uzee's SS ESH f Carnival's Euphoria; 5BC--E/C Dyer's CEW Rx f Keni Katz April; BK--W/S McCormick's BP Sia f Quin-Jo's Blu Etude; BP--R.Horenstein's Burm S Eksif Thami of Chin Hills LH: LILLIAN JACKSON'S BEST CAT--MISTY MORNIN' MARTY; 2BC--Lowlands Latecia of Kittrik; 3BC--Tania Yatisha of Feri-Purrs; 4BC--Justincase Jo Jo of Rambo; 5BC--D/J Greenburg's SP Him m Nevah-Tep's Seph of Janda; BK--Astro Acapulco Gold; BP--J/J Rambo's Blk Per N Lake Erie Tar Baby of Shah-Gai

MAR. 10, 1973, BOLTON, ENGLAND (GCCF) LANCASHIRE CAT CLUB

Best LH: D.Bebbington's PENKVALE CRYSTAL; Best LH Kitten: H. Murray's HARDENDALE ZALIDA; Best LH Neuter: M. Hall's DAVINDO'S PICKWICK; Best SH: D. Peak's CH. PRAETORIAN IMPERATOR; Best SH Kitten: P.Absalom's BRYNBUBOO BOSSELOT; Best Siamese: Mr. & Miss Fulton's HAPPYLEE'S FIREFLY; Best Siamese Kitten: H.Brown's ALDERLEIGH TAUNUS; Best Siamese Neuter: M.Fellows' GR.PR. KARAWONG TAIWAN.

MAR. 17-18, 1973, ARNHEM, HOLLAND (FIFE), FELIKAT C.C.

Best LH: M. Rossi's Cm m CH. YORK VON MEERHEESE; Best LH Kitten: M. Franke's BEW Pers ONSTEIN ROI DE NEIGE; Best LH Neuter: Cm ARABIAN NIGHTS' ACHMED; Best SH: Wht. Cornish Rx f LOHTEYN'S CLEOPATRA; Best Siamese: B. Eleveld-Veen's SP m DIANTHUS VAN FRANKENDAAL; Best Siamese Kitten: L. Reitbergen's TbyP m EKHLASS V.IBN. BATOUTAH.

MAR. 24, 1973, LONDON, ENGLAND (GCCF), SOUTHERN COUNTIES C.C.

Best LH Cat: J.McCarthy's CEW Per m DOLMEG TOPPLES; Best LH Kitten: M.Graham's Blu Per MARMSBURY CYMBELINE; Best LH Neuter: A.Green's Pr. OBERON OF PENSFORD; Best SH Cat: D.Peak's CH. PRAETORIAN IMPERATOR; Best SH Kitten: H. Cox's BERILLEON KUAN-YIN; Best SH Neuter: T. Harlow's SHA BE; Best Siamese Cat: M/M Hutton's SP m SISLINKI TOPSPUN; Best Siamese Kitten: A. Durrant's SIANJO TIBERIUS; Best Siamese Neuter: N. Farnsworth's PR. SATURN SEBASTIAN.

MAR. 24, 1973, ABERDEEN, SCOTLAND (GCCF) NOR'EAST OF SCOTLAND

Best LH Cat: E.Hoyle's Sm Pers f HARDENDALE LOOBY LOU; Best LH Kitten: M.G. Sucksmith's CP (Him) m PETITE POINT PACEMAKER; Best LH Neuter: M. Byrne's BYRNETTS HORATIO; Best SH Cat: E.Allday's Hav m SWEETHOPE CHICO; Best SH Kitten: D.Barracough's Aby m CONTENTED CIAMBRIELLO; Best Siamese Cat: M. Key's SP m KALOKE PHARAOH; Best Siamese Kitten: W.Ferguson's SP m SEADOG PEDRO; Best Siamese Neuter: S.Hibbert's CP MOS-TYN MAI WAIN.

APRIL 7, 1973, DUBLIN, IRELAND (GCCFI), SIAMESE CAT CLUB

Report from Mrs. Jo Cresswell. Best LH Adult: Mrs. & Miss Jones' Cm f DUNTON JOY; Best LH Kitten: Mrs. M'Neilly's Blu MOYLINNEY BLUE VISION; Best SH Adult: Lady Holmpatrick's Bn Bur m KEVITOR BROWN BRANDY BUCK; Best SH Kitten: D.Cresswell's Dev Rx f WENGRAM PREMIANNA; Best SH Neuter: Miss Robinson's ALBA SHONA; Best Siamese Adult: Mrs.Green's SP CASUARINA MORAN; Best Siamese Kitten: Mrs. Picken's LP TIRKANE SILVER MIST; Best Siamese Neuter: Miss B. Sullivan's QUEENSDALE ALFIE.

APR. 14-15, 1973, FRANKFURT, GERMANY, (ICFCE) DEUTSCHER K-C

Report from Mme. Cellier-Abry. 300 entries. Best LH: Mme. Hiberty's Blu Per m Int.Ch. SIGURD DE LA VALLIERE (France); Best LH Female: Dr. Beking's OEW Per f FELICITY DE ROCAWINI (Holland); Best LH Neuter: Mme. Voets' Blu Per HANNIBAL VAN WALENBURG; Best LH Kitten: Mme. Hiberty's Blu Per f VALERIANE D'ARGENTOLE; Best SH: Mme. Cellier-Abry's Bn Bur f Qd.Gr.Ch.Int. ADLE SURABAYA MY-DIEM (France); Best SH Male: Mme Aveinier's LP Sia TCHAIKO DE SURABAYA (France); Best SH Neuter: Mme. Wingerden's Euro ST Pr.Int. BALOU HARLANDES (Holland); Best SH Kitten: Mme. Craane's Hav f TWINKLE STAR'S TIMANDRA and Mme. P de Meer's CP Sia m CINNAMON'S DANDILO (both Holland).

APR. 28, 1973, PORTLAND, OREGON (CFA) LEWIS & CLARK LH C.C.

Results from Co-Master Clerk Robert E. Fenton. AB: WAYNE PARK'S BEST CAT--#75 R.EVERETT'S RDY ABY M PHAROH CITATION OF SWINGATE; 2BC--#58--C/M Lees' Tor Per f Kalamar's Danarca II; 3BC--#40--H/H Callaghans' Blk Per f Vagabond's Turvy Topsy of Con Meo; 4BC--#93 C/R Naces' Blk ESH m Kalamar's Kahula; 5BC--#21 H/H Callaghans' BEW Per f Babalong Petunia of Pitt; BK--A.Kimball's W Rx f Millcreek's Christina; BP--B.Ryall's SP Sia N West's Ming Le Chat. AB: PAUL RAINE'S BEST CAT--#75; 2BC--L.Carpenter's SP Sia f Lesnells Roxi-Anne; 3BC--#26 H/H Callaghans' CEW Per f Vagabond's Dilly Dally; 4BC--J.Peterson's BP Sia f Che-ree Ondine of Shy-Ann; 5BC--#58; BK--#1R/J Wilkinsons' BEW Per m Bobbi-Jean's Determine; BP--#130 J.Culpepper's Bur S Brown Bun; LH SP: WILL THOMPSON'S BEST CAT--#58; 2BC--#40; 3BC--#26; 4BC--#60 M/M R.Gerbers' Tor Per f Treasure's Pansy Puss 5BC--#21; BK--#1; BP--#121 M/M H.Mathiesens' CEW Per S Wild Rose Teacup. SH SP: WILL THOMPSON'S BEST CAT--#75; 2BC--#115 R/R. Rogers' LP Sia m Santana's Podgorny; 3BC--#93; 4BC--#86 D.Sears' Bur f Sears Li'l Chocolate Drop; 5BC--#111 F. Ames' SP Sia f Ru-Bon's Sorceress; BK--#19 M.Quire's BP Sia f Thaibok Titania; BP--#130. LH SP: JIM KILBORN'S BEST CAT--M.St. Elois' CEW Per m Vagabond's High Society; 2BC--#60; 3BC--C.Nielsen's CEW Per f Empath's Baby Dahl; 4BC--#58; 5BC--#21; BK--#1; BP--#121. SH SP: JIM KILBORN'S BEST CAT--#75; 2BC--#115; 3BC--#93; 4BC--#86; 5BC--#111; BK--#19; BP--#130.

APR. 28-29, 1973, CHARLOTTE, N.C. (CFA), CATS OF CHARLOTTE

Marked catalog sent by Mrs. Helen S. McFadden.

AB: ADAM FRECOWSKI'S BEST CAT--#75 L.WILLWERTH & D.BANDY'S BLU PER F LOWLANDS LATECIA OF KITTRIK; 2BC--#148 M/M D.Yod-ers' Blk Sm ESH f Docia-Dao's Trilby; 3BC--#129--H.Smith's Bur f Chinguapin's Puff N'Stuff; 4BC--B.Witbeck's RT Per m Tabbyland's Tooter; 5BC--#79 M/K Carrolls' Cr Per m Kohinoor Olympian; BK--E/D Dimens' Rdy Aby f Cactet's Casanova; BP--#221 M/M J.Pavics' Sh Sil S Per Kitza Adora of Nor-Mont. LH SP: BORIS TERON'S BEST CAT--#75; 2BC--J.Ferguson's Sh Sil Per f Tania Yatisha of Feri-Purrs; 3BC--#97 B.Witbeck's Bn Tby m Per Tabbyland's Toby; 4BC--J/J. Rambos' Cm Per m Just-incase Jo Jo of Rambo; 5BC--M.Carroll's BC Per f Kohinoor Morgain Le Fay (#104); BK--#10 P.Gude's RT Per f Pegsden Paulette; BP--#221. SH SP: BORIS TERON'S BEST CAT--#148; 2BC #129; 3BC--#119 N/A. Silvers' Cam Mk ASH m Mr. Peter Pan of Bams; 4BC--M.Drake's Rdy Aby m Genandra's Alex; 5BC--#180; BK--P.Maass' LP Sia m Fanfare's Calculator; BP--#229--W/D. Cummings' Burm S Phi Line Libra of Kaos. LH SP: DONNA THOMPSON'S BEST CAT--#75; 2BC--#79; 3BC--#93B.Witbeck's ST Per f Tabbyland's Talcum; 4BC--#104; 5BC--#97; BK--#10; BP--#221. SH SP: DONNA THOMPSON'S BEST CAT--#129; 2BC--#148; 3BC--#180 4BC--#119; 5BC--Dr/M M.Beckers' LP Sia f Hasul's Margolit; BK--D.Hansen/R.Peltz' Blu ESH m Heritage's Mr. Fezziwig; BP--#229. AB: LYNNE BECK'S BEST CAT--#75; 2BC--#148; 3BC--#93; 4BC--J.Shaw's W Mx f Kelsha Lily; 5BC--#79; BK--H.McFadden's Rd Per f Catspurr's Carmesi; BP--#229.

APR. 28-29, 1973, OKLAHOMA CITY (CFA), OKLAHOMA CITY CAT CLB.

Marked catalog sent by Mrs. C.W. Pallady.

AB: RICHARD GEBHARDT'S BEST CAT--M/M J.FLANAGAN'S BEW PER F XERXES DIVINITY; 2BC--#116 Ms.K.Duncan's BnTby Per m Silver Willow's Don Roi of Duncan; 3BC--#151 P.Klepinger's Rd Aby f Gaines Penelope of Pussy-Pur-Mew; 4BC--#163 A.Frecowski's Tor ASH f Rococo Ruby Petunia of Adam's Rib; 5BC--#86 K. Preston's Cm Per m Woodland Bear of Just So; BK--#9 H/J Sicard's Blk Per f Babalong Kewi; BP--#260 E/C Browns' OEW Per S JB Showpiece of Jo-Ni. SH SP: DON YODER'S BEST CAT--#144 M/M C. PALLADYS' RDY ABY F PALLADY'S GABRIELLE; 2BC--163 3BC--#170--J.Batchelor's Bur m Tok-Lat's Little Awful Arnie; 4BC--S.& Ms.W.Thompsons' RB m Velve's Gone Blue of Les Joy; 5BC--#151; BK--M/B Crotzers' SP Sia f Sin-Chiang's Riikola; BP--M/M F.Pinnocks' Bur S B'Miwa Mocca Gem. LH SP: DON YOD-

EDITORS' PREAMBLE (CONTINUED FROM PAGE 3)

EXHIBITORS BADGES

Special CAT WORLD exhibitors badges will be given to cat clubs anywhere in the world for use at their shows as long as the supply lasts. Each badge measures 3 1/2" x 2" and is printed on 50-lb cover stock. Personalized with Club name, the badges come in sheets of 12 to make it easy for entry clerks to type on the names of exhibitors.

Interested Clubs should estimate the number of exhibitors who will be attending the show when requesting their supply of free badges. This should be done at least three months in advance of show date (four months for overseas clubs).

WANTED: CAT WORLD 'AMBASSADORS'

Help is needed in spreading the word to breeders and exhibitors everywhere about this new magazine edited specifically for their interests. All present readers and cat clubs, anywhere in the world, are invited to become CAT WORLD 'Ambassadors'.

If you are interested in helping, please send us your name, address and the number of order forms you can use. We will send these to you, together with a code number which you should enter on each form you give out.

For each new subscription received on a form coded with your number, we will give you an advertising credit of 40¢ U.S. (15p for U.K. residents) to be applied against your future advertising in CAT WORLD. You will be notified annually of your advertising credit total.

COMING NEXT ISSUE

Some of the finest cats in Europe will be mentioned next issue when Mme. Gethmann reviews the highlights of the ICFFE shows and we meet some of the new 1973 G.C.C.F. Champions.

Advertising deadline is August 4, 1973. Why not take advantage of CAT WORLD's low breeder advertising rates (see next column) and spotlight some of your own prized show stars and potential winners for the new season?

SUBSCRIPTION RATES

6 ISSUES PER YEAR

PAYABLE IN U.S. DOLLARS OR BRITISH STERLING

\$4.50/£1.60 (\$9.00/£3.80 AIRMAIL)

PLEASE STATE ISSUE WITH WHICH SUBSCRIPTION IS TO START. THOSE WISHING TO RECEIVE ALL ISSUES PUBLISHED TO DATE SHOULD REQUEST ORDER BE BACKDATED TO MARCH/APRIL, 1973.



RAMONDA HIGHLIGHT, Best Siamese kitten at the Suffolk & Norfolk Cat Show, Kings Lynn, England, is a Lilac Pt. female bred and owned by Mrs. H.D. Stephenson.

ER'S BEST CAT--#118 J.PEVEY'S BN TBY PER F WYNDEN'S ROBIN; 2BC--#86; 3BC--#73 D/M Hall/W.Derouins' Blu Per m Dunhova's Playboy of Tra Mar; 4BC--#116; 5BC--M/M C.Sayers' BC Per f Country Club Candy Cane; BK--Ms.F.McPhee's BC Per f Raintree Lane Sunbonnet of Co-Mc; BP--#260. AB: KIM EVERETT'S BEST CAT--#144; 2BC--#163; 3BC--#170; 4BC--#151; 5BC--#236 C/C Rogers' SP Sia f Tres Bien Tricia of Rogers Hts.; BK--D. Mare's SP Sia f Sin-Chiang Kali of Mar-Ray; BP--#270--D/J Thompsons' Bur S Alpatra's Bayou Belle of Jo-Don. SH SP: JACK WELLS' BEST CAT--#170; 2BC--#144; 3BC--#236; 4BC--M. Eaton/D.Hopkins' SP Sia f Hi-Styles Minga of Jando; 5BC--Ms.R.Atwell's BP Sia m Geo-Jes Baron of In Lieu; BK--M. Farrell's BnTby Mx f Blu-Mist Marquise; BP--#270. LH SP: JACK WELLS' BEST CAT--#118; 2BC--#73; 3BC--#116; 4BC--M/K Prestons' Blu Per m Woodland's Thunderball; 5BC--I.Means' SP Him f San Su Lin; BK--#9; BP--#260.

*Advertising deadline is
AUG. 4 for next issue*

**"CAT WORLD" BREEDER
ADVERTISING RATES**

1/6 PAGE	U.S. \$ 9.00	U.K. £ 3.60
1/4 "	12.00	4.80
1/3 "	15.00	6.00
1/2 "	22.00	8.80
FULL "	40.00	16.00

PHOTOS: Black-and-white photos can be used in advertisements at a cost of \$4.00 each (£1.60).

DESIGN: If you wish, we will design your advertisement for you. There is no charge for this service. Simply tell us what you want to say and enclose photos to be included. We do not send advertising proofs. In case of an error on our part, a make-good advertisement will be given.

PAYMENT: Advertisers who send payment in full with order may deduct 5% cash discount from space rate. All others please include half of total cost with order and remit balance due upon publication. Payment may be made in U.S. or British currency by check, money order or postal order.

RATES: Rates quoted above are for publication in one issue. There is a 10% discount for each insertion on advertisements which are to run 3 times or more.

'PERUSE & CHOOSE' ADVERTISING: Print or type your message on a plain sheet of paper, indicate breed (or other) title under which it is to appear, and mail with payment in full please. (Note: Cash discount does not apply on 'Peruse & Choose' advertising). See page 32 for rates.

5395 South Miller St., Littleton, Colorado 80123 U.S.A.

Ph. (303) 986-0442

WORLDWIDE SHOWGUIDE

DATE	PLACE	ASSN	CLUB	JUDGES	INFORMATION CONTACT
IMPORTANT: PLEASE REFER TO MAY/JUNE ISSUE FOR OTHER SHOWS SCHEDULED DURING JULY, AUGUST & SEPTEMBER					
AUGUST					
4-5	Roskilde Denmark	FIFE			
11	Narara-NSW Australia	RASCC	Central Coast C.C.		Miss V. James, 8 Fountains Rd., Narara, NSW 2251
25	Springwood NSW-Austr.	RASCC	Blue Fountains Cat Society		Miss L. Fookes, 164 Hawkes- bury Rd., Springwood 2777
SEPTEMBER					
8	Twynneville NSW, Austr.	RASCC	Illawarra Pedigree Cat Fancy		A. Robertson, 110 Tipps St. Twynneville, NSW 2500
8	Redhead NSW, Austr.	RASCC	Newcastle & Hunter Valley Cat Club		Mrs. L. Manhart, 54 Hutchin- son St. Redhead, NSW 2301
8-9	Antwerp Belgium	FIFE			
15-16	Randers Denmark	FIFE			
22	Cork Ireland	GCCFI	Cork Cat Club		M. Baker, c/o O'Kennedy- Brindley, 26 McCurtain St. Joyce Irwin, Box 20803 San Diego, Ca. 92120
22-23	San Diego Calif.	ACFA	Silvergate	Lenox, Kahn, Hight, Rebello	
22-23	Anvers France	FIFE			
29-30	Skovde Sweden	FIFE			
29-30	Framingham Mass.	CFE	Mass. Colony Cat Club	Ramsden, Ligon, Lechtanski, Lazar	J. Boyd/R. Bangs, Box 2572 Framingham, Mass. 01701
OCTOBER					
6	England	GCCF	Yorkshire County Cat Club		Mrs. M.G. Baxter, 117 Spen- cer Place, Leeds 7.
6	Cross Rds. NSW, Austr.	RASCC	Macquarrie Cat Society		P.A. Townley, Shalem, Glen- field Rd. Cross Roads, 2170
6	Armidale NSW, Austr.	RASCC	New England Cat Club		Mrs. W. Rand, 76 Markham St. Armidale, NSW 2350
6-7	Bourges France	ICFCE	Cercle Félin de Bourges		Mme. Caillard, 11 Rue Ville- bois, Mareuil 18, Bourges
6-7	Copenhagen Denmark	FIFE			
6-7	Helsinki Finland	FIFE			
7	Miami Florida	CFA	Miami Florida Cat Fanciers	V. Wolfe, Don Williams	Ann Costello, 3071 S.W. 11 & Miami, Fl. (305-649-7257)
13	Dublin Ireland	GCCFI	Dublin Cat Club		Mrs. C. Dalgetty, 40 St. Brid- gets Rd. Clondalkin, Dublin
6	London England	GCCF	Siamese Cat Club		Mrs. M. Dunnill, The Garth, High Lane, Haslemere, Surrey
10	London England	GCCF	Longhaired Cat Club		Mrs. B. Barron, 54 Sweetcroft Ln. Hillingdon, Mddx.
13-14	Bergen Norway	FIFE			
13-14	Mons France	ICFCE			Mr. Honore, 92B Route d'Obou d'Obourg, 7000 Mons
13-14	Portland Oregon	ACFA	Willamette Valley Cat Club	Holm, Shore, Haralampus, Harding, Chapman, Morgan	Mrs. S. Field, 5545 SE 128 Av Portland, Or. 97236
20	Galston NSW-Austr.	RASEC	Blue Point Siamese Cat Club		Mrs. D. Davis, 17 Crosslands Rd. Galston NSW 2159
20-21	Lyon France	ICFCE	L'Assn. Féline Rhodaniègne		Mme Cellier-Abry, 11 bis Ave de Lyon, 73 Chambéry
20-21	Sault Ste. Marie, Canada	CFA	Soo Cities Cat Fanciers	Field, Teron, Bebout, Carroll D'Ambrosio	Mrs. S. Niel, 11 Selkirk Rd. Sault Ste. Marie, Ontario
27	Dunfermline Scotland	GCCF	Edinburgh & East of Scotland C.C.		Mrs. C. Lowe, 95 Inchview Terrace, Edinburgh EH7 6TT
27	England	GCCF	Midland Counties Cat Club		Mrs. M. Groom, 4 Orchard Lea Naunton Beauchamp, Worcs.
27-28	Charlotte N.C.	CFA	Cats of Charlotte	Jackson, Willwerth, Lynne Beck Ehrhardt	Helen McFadden, 1521 Lark- field Ln. Charlotte, 28210



CAT CLUBS:

PLEASE SEND IN INFORMATION ABOUT YOUR NEXT SHOW. Free "CAT WORLD" exhibitors badges imprinted with Club name, should be requested 3 months ahead of show. These are available to Clubs anywhere in the world as long as the supply lasts.

Abbreviations: ACFA - American Cat Fanciers Assn.; CFA - Cat Fanciers Assn.; CFF - Cat Fanciers Federation; GCCF - Governing Council of the Cat Fancy; GCCFI - Governing Council of the Cat Fancy of Ireland; FIFE - Federation Internationale Feline d'Europe; ICFCE - Independant Cat Fanciers of the Continent of Europe; RASCC - Royal Agricultural Society Cat Club.

CATS' ACCESSORIES LTD.

1 NEWNHAM STREET - BEDFORD - ENGLAND

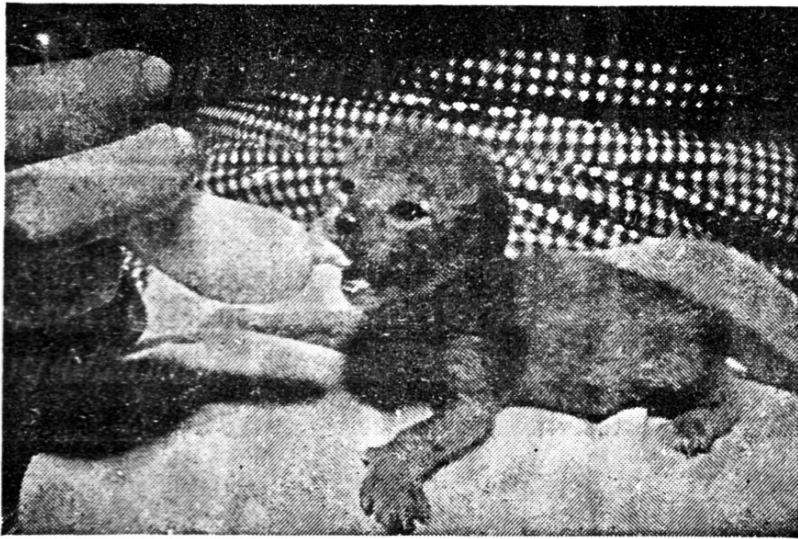

FOSTER FEEDING BOTTLES

FOR HAND-REARING &
WEANING ALL DOMESTIC
FARM & ZOO ANIMALS

2 SIZES

RUBBER BRUSHES

TO KEEP DOWN HAIRBALL
& FOR MASSAGE GIVING
GLOSSY COATS.

2 SIZES

- CB - For Cats & Small
Dogs
- DB - For Larger Dogs
& Horses



THE CAT LOVERS JOURNAL - \$1

YEARBOOK OF THE BRITISH CAT WORLD

SEND FOR RETAIL PRICE LIST:

CATS ACCESSORIES LTD.

1 NEWNHAM STREET, BEDFORD, ENGLAND

TRADE ENQUIRIES WELCOME

BULK RATE
U.S. POSTAGE
PAID
Littleton, Co.
Permit No. 233

**CAT
WORLD**
5395 South Miller St.
Littleton, Co. 80123

RETURN POSTAGE GUARANTEED

Vari-Kennel

Convertible Pet Apartment

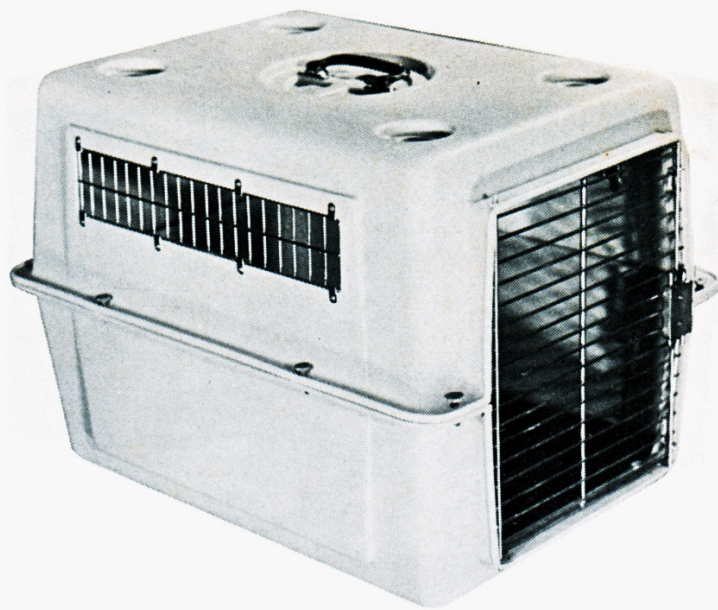

DO YOUR CATS DESERVE THE BEST?
For complete information write:

DOSKOCIL MFG.CO., INC.
DEPT. CW

P. O. Box 1246 • ARLINGTON, TEXAS 76010

SENTY-TWIX

MRS. NANCY HARDY
2 Cliff Terrace
Budleigh Salterton
Devon EX9 65Y England

CORNISH REX

QUEEN:

CHAMPION SENTY-TWIX CRISPATIS
(33) Tortie And White

Photo by Hill's
Studio, Exmouth

ZUREIQ A

CORNISH REX

MRS. R. W. HAMILTON
Haskers, Westleton
Saxmundham
Suffolk IP17 3AP England

AT STUD: SENTY-TWIX CRISPARIS - (33)
(33) Cream And White
SENTY-TWIX JASPAR
(33) Cream - Sire: AMASKA MUSCATEL (33)
Havana Brown Dam: CHAMPION SENTY-TWIX
CRISPATIS (33) Tortie And White

QUEENS: DuBU CINDERELLA
(33) Tortie - Sire: AMASKA MUSCATEL (33)
Havana Brown Dam: DU BU NANKYPOO (33)
SENTY-TWIX SAPPHIRE
(33) Blue - Litter Sister to SENTY-TWIX
JASPAR.



NONE OF THESE CATS HAVE ANY
GENE 2 REX IN THEIR BREEDING.
KITTENS FOR SALE.