

CAT WORLD

*magazine
for the
breeder/exhibitor*



November - December, 1973



A Tradition Of 60 Years Serving The Fancier Of Today!

- CFA gives you personal, friendly service backed up with computerized efficiency.
- The Central Feline Registry—CFA's concern for the individual breeder and the world-wide fancy.
- The CFA Breed Council—Each registered breeder's vote is weighed in revising standards.
- The CFA Show Circuit—Offers you more shows, coast to coast, than all other associations combined.
- CFA National and All-American Scoring—National recognition and cash prizes at no cost to you or your Club.



**Big Enough To Serve The Fancy ...
Small Enough To Serve The Fancier**

THE CAT FANCIERS' ASSOCIATION, INC.

P.O. Box 430

RED BANK, NEW JERSEY 07701

SID & PAULINE THOMPSON

Editors'

Preamble

COVER CAT

Lovely winner of the Himalayan Society's 1973 BEST KITTEN award, *BONNIVIER ANJALI*, bred by Mrs. Ralph Vierregger, highlights our cover. The Seal Point female, whose portrait was taken by Steve Pearce, lives with her breeder in Omaha, Nebraska, U.S.A.

IN THIS ISSUE . . .

Maine Coons and Tabby (Lynx) Point Siamese come to the forefront with an article on the former by Zig Kozaczka (p.6); and articles on the Tabby Points by Nancy Hardy (p.18) and Brunette Greenland (p.19). Mrs. Anne Aslin and Mrs. Pat Collins tell of the first Tabby Point Grand Champions (p.20).

Zig Kozaczka, who resides in Arizona, U.S.A., is a member of the Maine Coon Breed Committee of A.C.F.A. Mrs. Hardy was introduced when she wrote on the Rex in the May/June issue; Mrs. Greenland lives in Alton, Hampshire, England, and breeds Siamese and Foreign White cats and Afghan hounds.

The cat fancy continues to flourish in new areas. Thanks to Mrs. Anne-Marie Gasnier it is developing in Brazil where a F.I.F.E. show was recently held at Sao Paulo (p.10). French-born Mrs. Gasnier is president of the Clube Brasileiro Do Gato and has lived in Brazil for many years.

CAT WORLD is privileged to present the triumphant and touching story of *GR.CH. PHAROH RAMESES II* (p.14). Mrs. Kim Everett, his owner-breeder, is a busy and popular C.F.A. judge. She found time to write this tribute to a great Abyssinian on the planes which took her to judging assignments last season.

A special report on genetics of the Silver and Smoke, co-authored by Patricia Turner and Roy Robinson, follows the regular study unit in 'College of Cat Genetics' (p.25); Rosemonde Peltz looks at the British Shorthair in her 'Heritage' series (p.4); and British veterinarian, Julia May, writes about vetting-in at cat shows following a considerable amount of first-hand experience at the pre-show table.

CHRISTMAS SHOP IN 'CAT WORLD'

You'll find many Christmas shopping ideas as you turn the pages of this issue. A kitten is a welcome gift and breeders are advertising a good selection. (A word of caution to breeders: please give written instructions to

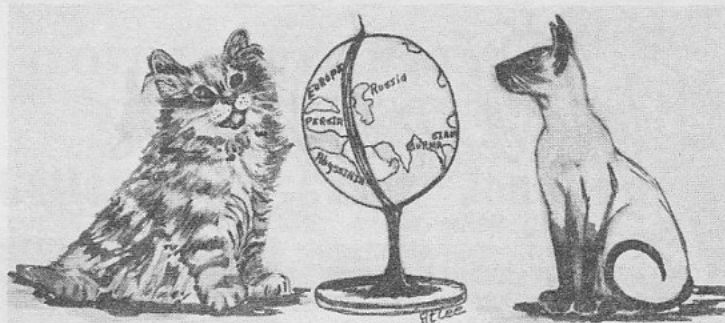

buyers of pet kittens concerning diet and care as well as the importance of keeping gift wrapping paper, string, tree ornaments, icicles, foil, etc., away from the little feline's reach).

In the exercise toy department, cats can obtain hours of enjoyment from Art Craft's novel Pet Trapeze (back cover). Three solid cork balls are suspended on bright stretch cords from a solid wood frame. It measures 14"x 13½".

For the exhibitor, a cat carrier is a most useful gift. The Vari-Kennel (p.22) is one of the best on the market. We have three in our cattery and find them to be the most satisfactory of any we've used.

Books make good gifts. Aby enthusiasts will enjoy the one by Rosemonde Peltz (p.24) and there's a variety to choose from in the list on p.35. Mrs. Hardy is giving CAT WORLD readers a chance to have one of the few copies remaining of Greta Hindley's book "Siamese Cats Past & Present". Once these are sold, she said, the book will no longer be available. It may be ordered from Mrs. Hardy (address, p.11) for \$1.50 via airmail, or 90¢ by surface mail. She will accept U.S. funds.

Of course, we'd like to suggest that you put CAT WORLD gift subscriptions on your shopping lists! (see p.35).

For yourself? Why not one of the new CAT WORLD binders which are now available at \$4.50 each! Twelve issues can be contained in a binder and the magazines will open completely flat for easy reference.

MORE "GREAT CATS"

We received news of four additional "Great Cats of Great Britain" too late for the special feature in the Sept./Oct. issue. One is *CH. LYDEARD BLUE JUAN*, Blue Burmese male born March 20, 1971, bred and owned by A.F. Pike, while the other three are cats from Northern Ireland. Mrs. Ross sent news of her Siamese Seal Point female bred by Mrs. Denny, *CH. PI-DEN HOURI*, born March 12, 1971, and her Seal Colourpoint female bred by Miss Rickson, *CH. GAYLORD MARGARETTA*, born March 30, 1971. Mrs. Peacock wrote about her Blue Per-

(Continued on page 12)

Vol. 1, No. 5, CAT WORLD © contents copyright 1973 by Cat World, Editorial, advertising & circulation office: 5395 South Miller St., Littleton, Colorado 80123 U.S.A. Published bi-monthly. Editorial content may not be reproduced without written permission. Opinions and statements expressed by contributors are not necessarily those of the editors. Subscriptions: U.S.A. \$4.50; Great Britain £1.80 (£3.60 airmail); all other countries \$4.50 U.S. (\$9 airmail). Single copies 90¢ (36p). 3rd class postage paid at Littleton, Colorado.

HERITAGE

ROSEMONDE S. PELTZ

CH. PENSYLVA BELLA, born November 1, 1961, was bred by Mrs. Richards. Her dam was CH. BROUGHTON JANE, sire CH. JEZREEL JAKE.



II - BRITISH BLUE, CREAM & BLUE-CREAM SH.

Before 1896 the shorthaired cat was more popular than the longhair, and, from the beginning, the blue has been an extremely appealing color variety. The native British shorthaired blue has been developed into a beautiful animal and has gained the interest of breeders in the United States as well.

In the earliest era Miss Cochrane owned *CHELSEA THISTLEDOWN*, *SPEEDWELL* and *GREY DAWN*,



but it was her cat *BLUE PETER* who won well as early as 1911. Among the early blue breeders were Lady Rachel Alexander who owned *BALLOCHMYLE BLUE KING* and *BROTHER BUMP*; Mrs. S. Woodiwiss had *BLUE BOY*, and Miss H. Hill Shaw owned *CHELSEA TWILIGHT*.

CH. PENSYLVA PANSY, Blue Cream, held 12 Challenge Certs. at the age of 5.



KUHL CATTERY
SPECIALIZING IN RED PERSIANS
ALSO RELATED COLORS

KITTENS AVAILABLE DECEMBER '73

Black males, red males & females, and cream male from the Gr.Ch. Silva-Wyte, Jack-A-Napes and Gr.Ch. Stonybrook Matt Helm of Kyle lines.

James M. Glenn 111

470 STONEWALL
MEMPHIS, TENNESSEE 38112

BankAmericard Ph (901) 275-4506

Little is recorded about the blue until after 1930 when *TWINK OF BLAYDON*, *MICKEY OF ODERSFELT* and *CAPER MIDGE* were on the scene. At about the same time the creams began to increase in popularity. Lady Rachel Alexander developed a winning cat in her *BALLOCHMYLE CREAM CRACKER*; *GALBRE*, belonging to Miss Bowley, and *CREAM COURTIER OF PLAICEY* shown by Mrs. Harper were also winners.

Perhaps the most significant event in the history of the British Blue occurred in 1943, a relatively late date in the history of cats, but that year marked the beginning of the most magnificent examples of the color and the breed. It was the time that Rev. B. Rees bred two excellent cats, *SYLVAN JOEY* and *SYLVAN TIMMY*. Although *JOEY* failed to sire, *SYLVAN TIMMY* was the predecessor of the finest lines in recent history.

The cream lines are closely intertwined for Mrs. J. Cattermole crossed a longhaired cream to *SYLVAN TIMMY*, and the resulting litter consisted of three cream males and two blue-creams. The females survived and one was crossed to *SYLVAN QUICKEE* who thus sired *MINGSWYCK APOLLO*, a cream male, and *MINGSWYCK BLUE PRINCE*.

How remarkable it is that the British Blues and Cream Shorthairs continued to do so well from 1943. Most breeds suffered greatly during the war years. The lines were established and continued. The Mingswyck cats and the Jezreel cats of Mrs. I. Johnson continued in popularity.

In the mid and late 1950's the blues, cream and blue-creams established the British Shorthairs in the hearts of American breeders. The blue-creams, although unrecognized officially, were developing well. In 1951 *MINGSWYCK MYSTERIOUS MAID* was born. Mrs. Phyllis Hughes and Mrs. Attwood were important breeders at that time.

BROUGHTON JANE, bred by Mrs. Hughes, was born in 1955. She resulted from a cross between a British Blue female and *DANEHURST PETER*, a cream longhair. Mrs. Hughes played a great part in achieving official sanction for the blue-cream.

CH. PENSYLVA QUICKEE, British Blue son of CH. JEZREEL JAKE and CH. BROUGHTON JANE, was born August 27, 1962.



Two years before *BROUGHTON JANE* was acquired by Mrs. Joan Richards, a very fine blue male was born. This was the famous *LITTLEWICKERS BLUE SERGE* bred by the Misses E. and C. Chatterton of Sussex. (Cont'd on p. 29)

Gallantree Abyssinians

(LOVE EGYPTIAN STYLE)

Proudly Presents :



GRAND
CHAMPION
GALLANTREE'S
CASEY JONES

CFA & ACFA GRAND CHAMPION

Gallantree's Casey Jones

CFA'S MIDWEST REGION BEST ABY & 3RD BEST CAT
ACCA'S 2ND BEST ABY MALE & 2ND BEST ABY (2nd year)
ACFA'S ROYAL ROYAL REGIONAL MALE OF BREED (3rd Year)
& ROYAL REGIONAL MALE OF COLOR OF BREED

GRAND CHAMPION

Gallantree's Hobie Cat

CFA'S MIDWEST REGION 4TH BEST KITTEN

Gallantree's Gadabout Jones

(GR.CH. GALLANTREE'S DAVY JONES SON)

Now in California with Larry and Sheryl English

■ AT STUD TO APPROVED QUEENS ■

WE WOULD ALSO LIKE TO SEND CONGRATULATIONS TO:

- GR.CH. VELVET'S ANKHAU (Casey son)
CATS MAGAZINE #1 ALL SOUTHERN CAT
- GR.CH. LAWDALE'S CENAYA (Casey daughter)
ON COMPLETING HER GRAND CHAMPIONSHIP
- GR.PR. GALLANTREE'S FIREBALL (Davy son)
ON COMPLETING HIS GRAND PREMIERSHIP
- GR.CH. EL QAHIRA'S DESERET (Davy daughter)
ON COMPLETING HER GR.CH. & BEING ACCA'S 3RD BEST FEMALE
- GR.CH. GALLANTREE'S HOT PANTS (Hobie's litter-brother)
ON COMPLETING HIS GRAND CHAMPIONSHIP
- CH. SIA-MEWS AMBER OF SHADY PAWS (Casey daughter)
ON BEING ACCA'S NORTHEAST REGION BEST FEMALE
- CH. RALLIM'S CAYENNE (Casey daughter)
ON BEING CLOSE TO HER CFA GRAND

FOR
WINNERS
BREED TO
PRODUCERS
OR INQUIRE ABOUT A
SHOW QUALITY KITTEN
TO PUT YOU IN THE
FINALS.

GRAND
CHAMPION
GALLANTREE'S
HOBIE CAT

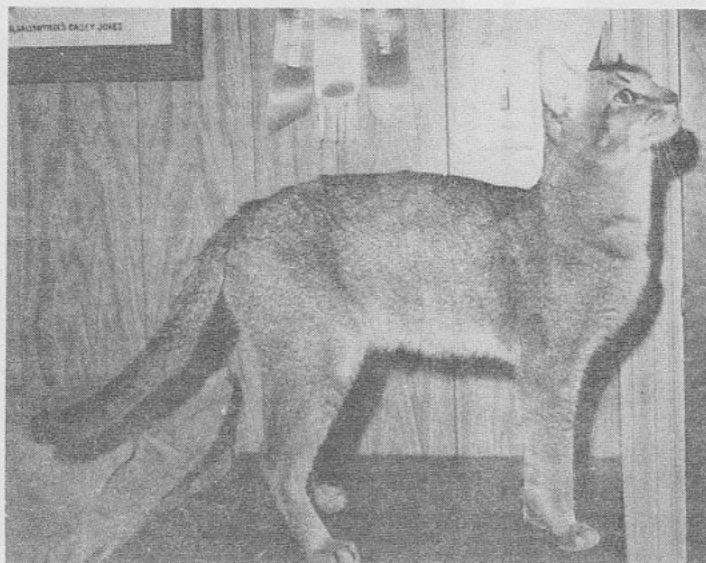

Phone :
(312) 223-0852

449 BARRON BLVD. (RT.83)
GRAYSLAKE, ILLINOIS 60030

CFA & ACFA REGD.



Merry Christmas

Happy New Year

AND MAY ALL YOUR

WINS BE FINALS!

RON & JUDY BAUER



MAINE COON CAT

BY ZYGMUNT KOZACZKA

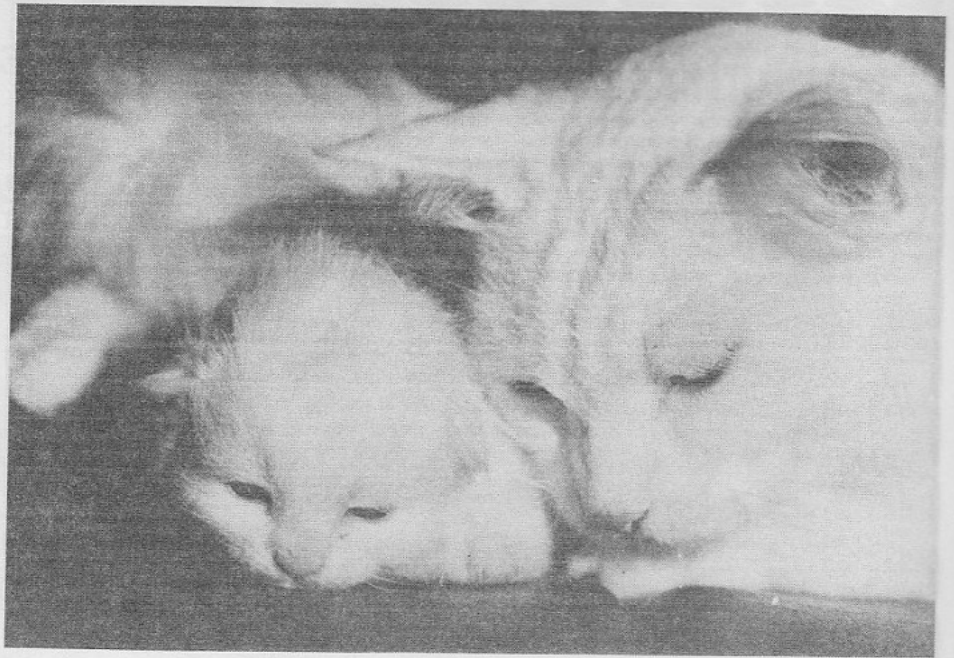

Thelma M. Suter's RM QUAD CH.
PRINCESS STASIA and kitten.

No cat in the fancy has more colorful legends surrounding it than the Maine Coon. Stories of sailors in the 1800's returning home to the East Coast of U.S.A. from foreign lands bringing their pets with them; Marie Antoinette shipping her lovely pets to the new world; and stories of Bob Cats mating with our own Domestic or with Canadian Lynx, and whatever else, to produce a large cat. As fascinating as these stories are, one must return to reality and find that the Maine Coon Cat of questionable origin has been the favored cat of the Northeastern United States for generations and was used by the farmers in the State of Maine to keep the rodent population down with such success that they

found their way into the farms of other Northern States where they were used for the same purpose.

In the mid-1800's the people of Maine gathered together for good times bringing with them their favorite, as well as what they regarded as their prize cats to tell tales about. Perhaps this started what we now call cat shows.

A Maine Coon by the name of *KING MAX* won the Boston Show in the very late 1800's. The first volume of the CFA Register listed 28 Maine Coon Cats. The Maine Coon dropped out of the show circuit in the early 1900's possibly because of the many new imported breeds. Interest in the Maine Coon remained in Maine, however, where often the townfolks put on a cat show of strictly Maine Coons. Passersby stopped in, liked what they saw, and the Maine Coon made its comeback into the show circuit in the mid-1960's.

The Maine Cat, 1973-style, is not quite as large as our ancestors deemed them to be. The average male at maturity (three years) ranges from 15 to 20 lbs. and the female 8 to 10 lbs. There are exceptions, of course, but the so-called 40-pounder, or anything close to that size, remains few in number; a conservative figure would be around 8 nationwide and most of them are neuters or spays. Perhaps because of its past colorful history, many people still believe the Maine Coon is indeed very massive. There isn't a Maine Coon breeder known who hasn't received inquiries from prospective buyers wanting nothing less than a guarantee of a kitten that will go to 30 lbs. or more!

The Maine Coon is a very friendly, intelligent and quiet animal. Its soft coat is unlike the Persian or Angora to the touch.

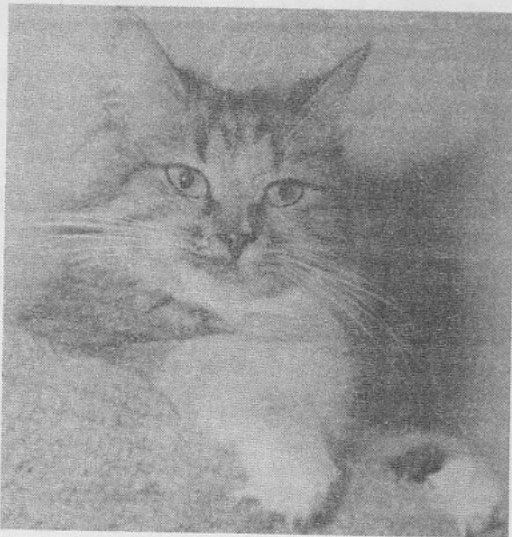

ZIG-KRN'S ENCHANTMENT, Torbie with White Parti-Color female poses for her owner-breeder, Zig Kozaczka.

The fur goes from short on the back to longer as it approaches the stomach and britches where it is the longest. Unlike the Persian, the body is long, muscular and powerful. The rump is slightly higher than the front. Delightful to the breeder and exhibitor is the little grooming required by the Maine. A few strokes with a comb and the cat is ready for a prospective buyer; a few minutes combing each day for a week and the cat is ready to be shown. The breed is extraordinarily healthy and, although like any other cat it can fall to a fatal disease, the minor problems of coughs, aches and pains are infrequent if non-existent. Deafness in the blue-eyed white is rare. There is a large variety of colors and patterns of Maines: they come in every known color as well as a few colors of their own. As one Maine Coon breeder puts it: 'the color of the rainbow plus'.

Over 2,000 inquiries have been answered by the Maine Coon Breeders & Fanciers Assn. since they were formed with a nucleus of six breeders in 1968. This organization has done more for the Maine Coon than anyone and now has members in 34 states and 5 Canadian provinces. Joining in the quest for the promotion and preservation of 'America's Original Longhair' was the Maine Coon Cat Society and the International Maine Coon Cat Society. June, 1972, brought about the beginning of a momentous occasion in the Maine Coon world. The three governing bodies of the organizations got together to begin a sorely-needed "Unified Standard". Maine Coons that were making finals with one association were being rejected by others. Judges in one association were looking for Foxy-Faced Coons; in others, Lynx; some for tails longer than the

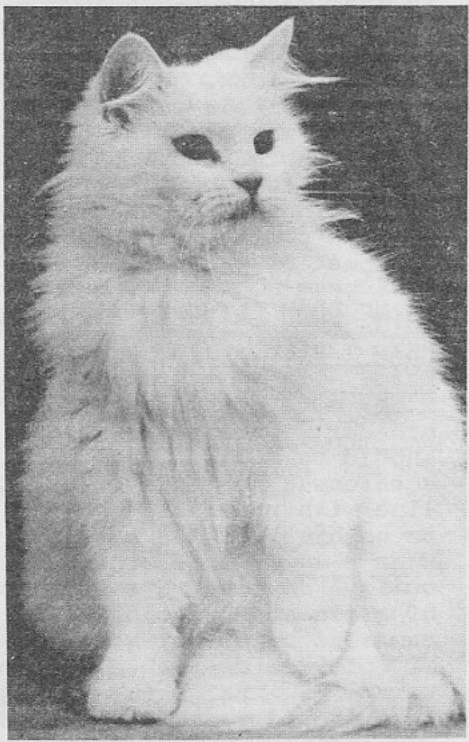

EMIN-DALE'S MA FERGUSON OF MOONEY, Copper-Eyed White female bred by E. E. & L.D. Eminhizer and owned by Maureen Jenkins, was ACFA "House of Maine" in 1971 & 1972.
Dorf photo

SUNGOLD

SABLE BURMESE ONLY

SHOW/PET QUALITY

CFA REGISTERED
MEMBER -- UBCF

Health Guaranteed
Dispositions Unsurpassed



HOUSE RAISED KITTENS FROM:

CH. SHY-ANN'S GRETCHEN OF SUNGOLD
CH. MOTET'S BALLADE OF SUNGOLD

**** INQUIRIES ANSWERED PROMPTLY ****

ARYLINE STROBEL

Phone: (213) 671-6994 Evenings
1203 WELTON WAY, INGLEWOOD, CA 90302



KORATS

THE SILVER BLUE NATIVE OF THAILAND

AUTHENTIC THAI BLOODLINES EXCLUSIVELY.

INQUIRIES RE MEMBERSHIP, CATS, KITTENS
SEND 50¢ (or International Reply Coupon,
obtainable at Post Office, if inquiring
from overseas) to:

KORAT CAT FANCIERS ASSOCIATION

Mrs. Richard Negus, President
6633 North 44th Avenue
Glendale, Arizona 85301
Phone: (602) 931-8503



ENCHANTA NOEL (BP)

ENCHANTA

Himalayans

SEALPOINT, CHOCOLATEPOINT & SOLID CHOCOLATE
KITTENS AVAILABLE NOW.

FOR PEDIGREE INFORMATION AND PICTURES WRITE:

G. WERTHEIM

16710 LILLYCREST, SAN ANTONIO, TEXAS 78216

(512) 694-3301

AT STUD:

TOP
REGIONAL
CHOCOLATE
POINT

MINGCHIU

EMIR

body (like a monkey); and others, if they did not find it a struggle to carry the cat from judging cage to judging table, deemed it too light. It was a consensus of opinion of all Maine Coon breeders that they should come up with a Standard that would best serve the Maine Coon and its breeders. In early January, the final ballots went out to members of all Maine Coon organizations and a "Unified Standard" was adopted.

First to accept the Unified Standard was America's second largest cat association, ACFA. At this writing, it has also been accepted by Crown and UCF although the latter, like CFA, does not recognize the Maine Coon for championship competition, waiting to see how many are registered and shown within its body. All national associations as well as all judges in the U.S.A. and Canada will receive copies of the new Unified Standard and it is hoped that it will be adopted by all so as to allow the breeder/exhibitor freedom to show in all shows within his home limits with the knowledge that his cat will be judged to the same Standard in all associations.

The first association to accept the Maine Coon for championship competition was Canadian Cat Association. America's leader, and original "show home" of the Maine Coon, Cat Fanciers Association, has not accepted the Maine Coon for championship competition waiting until one hundred cats are registered.

NEUTERS WIN FIRST GRAND TITLES

First Maine Coon Cat to become a Grand Champion was *SIR DRIFTWOOD OF PUPULI*, White

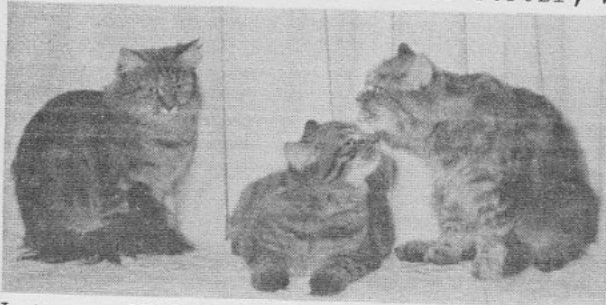

L to r: QUAD CH. ALL SAINTS CHRISTA OF LYB-E, CH. LYB-E'S KAREN'S KELLE, and QUAD CH. ALL SAINTS KAREN OF LYB-E. This trio is owned by Elizabeth Broach.

neuter owned by LaVera Miller, Glendora, California. He won the title in ACFA in 1970 and, since then, three others have also earned it. However, no entire Maine Coon has yet become a Grand Champion in ACFA which may be due to misconception as to the size of the Maine Coon or to the limited opportunities to show ACFA in the East where entry of 20 or 30 Maine Coon Cats at a show has been common.

Since 1970 several of the breed have become Grand Champions in other associations including *MOR-ACE'S SATAN*, Brown Tabby male owned by Anthony Morace, Springfield, Mass. This cat received the Danish Medal (Danish Cat Club) and is a Grand Champion in three associations, ICF, ACA and CFF. Particularly proud of his feat is his father, *CH. O'NO OF ZIG-KRN*, the author's Black Smoke. Another well-known magnificent Maine Coon is Double Grand Champion (ICF-ACA) *DAUPHIN DE FRANCE OF TATI-TAN* owned by Sonya Stanislow, New York. In 1971 *MIEOUS DANALISCOTTA*, Red & White Parti-Color female reached Grand Champion status in Crown: she is owned by Muriel Corigan, New York. Many other Maine Coon Cats have won finals on both coasts in ACA and are on their way to Grand Championships.

With the adoption of the Unified Standard, it is hoped that the fabled 40-pounder is a thing of the past and that many more of America's original Longhaired cats will reach the peak of perfection.

MAINE COON CAT - UNIFIED STANDARD

HEAD (30 Points):

Shape - 15 - Medium in width, except in the older more developed studs where it should be broader. Cheek bones high. Nose and face should be medium long, with an appearance of squareness to the muzzle. Chin firm and in line with upper lip and nose. Slight break or no break in the nose.

Eyes - 10 - Large, round, wide set. Slightly oblique setting. Eye color should be shades of green and or gold. In white cats eye color may also be either blue or odd eyed. Clarity of color is desirable.

Ears - 5 - Large in size and wide at base. Ears should taper to a point, and be tufted.

Undesirable - Short flat face, or long point-

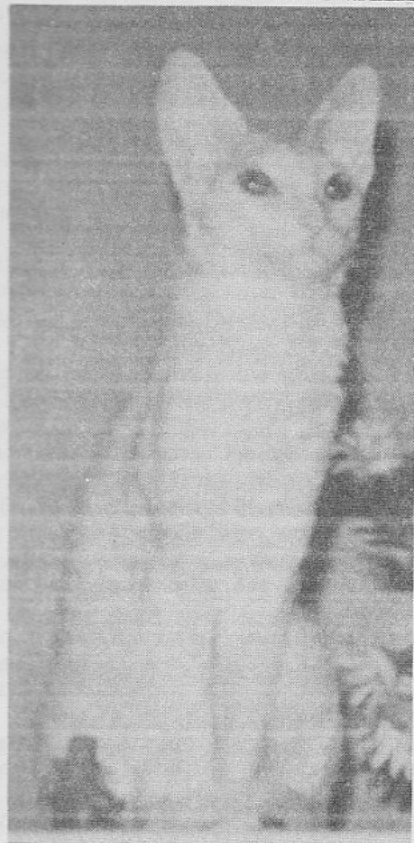

RAE-L Cattery

GENE I REX (CORNISH)

CFA GRAND CHAMPION & ACFA GRAND CHAMPION

NIKE GLYNDA OF RAE-L

GLYNDA HAS SOME NICE SHOWY KITTENS, READY NOW,
IN BLUE, BLACK, SMOKE, ALSO WHITE.

MRS. HELEN K. BATES

Phone: (602) 255-5651

2125 WEST VERDE LANE

PHOENIX, ARIZONA 85015

ed nose. Undershot chin. Narrow eyes. Very slanted eyes. Dull eye color. Short, rounded, narrow set, or untufted ears.

BODY (30 Points):

Shape - 15 - Muscular, powerful, and long. The cat should be medium to large in size, females slightly smaller. The chest should be full. All parts in proportion. When viewed from the rear there should be a definite squareness at the rump.

Neck - 5 - Medium long giving the appearance of length to the body. In the older, more mature cats, especially studs, the neck should be thick and muscular, giving the appearance of power and strength.

Legs & Feet - 5 - Legs substantial, muscular, wide set, of medium length, and in proportion to body length. Paws should be large, round, and well tufted.

Tail - 5 - Long and full. Wide at the base, and should taper without kinks.

Undesirable - Short cobby body. Delicate bone structure. A rounded rump. Short legs and untufted feet. Kinked tail.

COAT (20 Points):

The fur on the front shoulders is shorter and should become gradually longer along the back towards the tail, ending in a shaggy, heavy coat on the britches. The sides of the cat's coat should gradually get longer until the stomach is reached, where it should be long and full. A full ruff is not expected; however, there should be a slight frontal ruff

beginning at the base of the ears. The fur on the tail should be long and full. Feet and ears should be tufted. The coat should be fine, heavy, and should fall smoothly. The coat should have a lustrous sheen, but should not be excessively oily or dull. A slight undercoat may be carried. This is the optimum coat and will vary with climate. Cats shall not be penalized for less than a full coat during the warm season, nor shall they be penalized for a very full coat.

Undesirable - Even length of coat.

COAT COLOR (10 Points):

White, Black, Blue, Red, Cream, Silver, Cameo.

Smokes: Black, Blue, Cameo

Tabby: Silver, Cream, Red, Brown, Blue, Cameo.

Mackeral Tabby: Silver, Cream, Red, Brown, Blue, Cameo.

Tortoiseshell, Torbie, Calico, Blue-Cream, Bi-Colors, Parti-Colors.

White trim around the chin and lip line allowed except in solid color cats. Winners not to be withheld for buttons or lockets.

CONDITION (10 Points):

Solid, firm, muscular. Should be presented in a well-groomed manner.



HOLIDAY GREETINGS

We wish the happiest of holidays to cat fanciers all over the world ... and from our cats to your cats--Merry Christmas and Happy 1974! Sid & Pauline Thompson

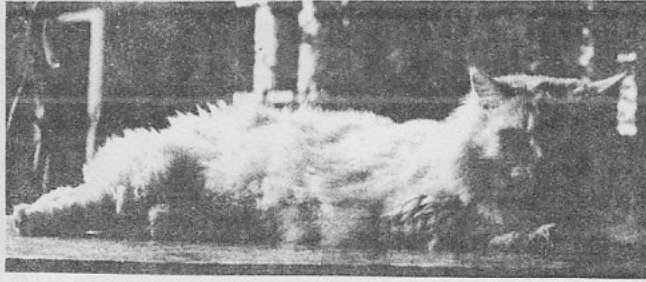

THE CAT FANCY IN BRAZIL

BY ANNE MARIE GASNIER

This is the story of the creation of a cat club in a country remote from the great cat breeders' associations.

Some years ago, the situation of the cats in Brazil was very discouraging. The common cats were often mistreated by people who attributed them with the most absurd faults and beliefs based on legends of the Middle Ages. Persian cats were all but non-existent; small quantities of hybrids, from chance matings between shorthairs and long-hairs, were about the best to be found. Siamese cats were totally out-of-standard: they had round heads and eyes while many had short or kinked tails.

Nobody thought of the possibility of improving the cats by importing from countries where pedigreed cats were carefully mated and no cat breeders club existed to assist cat fanciers. Another negative fact was excessive in-breeding and, on top of all this, the standards were completely unknown.

In 1962, I had an opportunity to learn how little was known about the Siamese. I took a kitten I had just bought to a veterinarian and was told that I had made a very bad choice "as this breed is very difficult to raise and the weakness is inherent in this race". So far as the fragility of these animals here was concerned, he was right. Siamese, more often than not, "broke like glass" due to acute rickets!

With this picture before me, I promised myself that I would prove to everybody that this whole situation could be improved. There was a good deal of work to be done but, with perseverance, good results were bound to be obtained.

BREED IMPROVEMENT

Our first intention, as we had bought a Siamese kitten, was to take good care of this fragile animal but, a few days later, it fell from a fence less than two feet high, broke its back and had to be put to sleep. My feelings toward the breeder were not very kind but I later understood that she was not completely guilty as, like other breeders

PHOTOS: TUFFY, Chinchilla female born Feb. 17, 1969, Glendale's Arch Deacon x Glendale's Sara Burn-Hart, was bred by Mrs. Ruth Wilson and is owned by the author. PUCE (rt.) was bred by M. Shirley Oba and was born Dec. 23, 1971. This female Birman is owned by Thierry Gasnier. Sire & dam are Tshyphou & Baly.

here at that time, she ignored everything on rational and scientific breeding.

To soften our grief, we ordered a kitten from another breeder who, two months later, with little explanation, delivered us a long-haired kitten with white feet instead of the Siamese that we had ordered, and told us it was a Sacred Cat of Burma (Birman). We had managed, by luck, to have one exemplary of a race completely unknown here. This kitten, too, had an initial stage of rickets but we were above to control it.

Later we bought a Blue Point Siamese and, to obtain better results, took the kitten at the age of only one month. It was risky but we felt it was safer than to leave it with the breeder. The kitten grew up to be a very healthy cat so we were very pleased with the success we attained.

We had won our first two battles on the health problem thanks to the dedication of our veterinarian, Dr. Marina Moura.

Books on cats proved difficult to obtain locally but some friends brought books from the U.S. which we needed. My first aim was to get information on breeds and standards currently recognized.

At the time we bought our Birman, it was impossible to buy a female and, not knowing that later we could import one, we tried back-crossing to Seal Point Siamese to maintain the breed here. After three generations we managed to obtain some animals which could be considered Birmans although not of championship quality. Most of his offspring were spayed or neutered as we wanted to avoid procreation of cats who differed too much from the official standard.



Up to this time, our work was based only on what we read in books and personal experience with our cats (ten cats and various kittens plus some one hundred cats of other people).

We succeeded in obtaining two other Siamese colors. An American couple brought a Chocolate Point Siamese with them when they came to Brazil and mated her with my Blue Point. In the second generation, with mathematical precision, in one litter were: one Chocolate Point, One Lilac Point and one Blue Point (at least according to the description in the books).

FOUNDING THE CLUBE BRASILEIRO DO GATO
The reading of English and American books on different breeds made us realize the necessity of contacting foreign associations who might help us. We wanted, above all, to know more about modern methods of breeding.

The books we collected gave many repetitions of elementary advice and the ones with more profound information were few. We began to understand why breeders here encountered so many difficulties when we could find only one book, quite an elementary one, published in the Portuguese language.

During a business trip to Europe, my husband had the good fortune to become acquainted with a charming person, Mme. M. J. Ravel, President of Honor of F.I.F.E. and Chairman of the Cat Club de Paris. He explained our problems to her and Mme. Ravel agreed to fight with us for our cause. This was the real beginning of our Club.

To form a Club, we counted on the many cat fanciers, veterinarians, university professors, lawyers, housewives and others whom we had contacted in the earlier phases. In this way we assembled a group of fifty people who became the founder-members. Newspaper reporters helped by publishing news of our new Club. To all these people, we give thanks in the name of all cats in Brazil!

Legally founded on September 22, 1972, the Club began its activities by promoting its purposes and trying to gain more members. This was not easy for not everyone was willing to pay the annuity nor the money to register his cat.

AFFILIATION WITH F.I.F.E.
It was with great joy that we received the support of the F.I.F.E. (Federation Internationale Feline D'Europe). In a general assembly on December 9, 1972, in Amsterdam, they recognized the CLUBE BRASILEIRO DO GATO and let us know that after our first exhibition the club would be formally accepted.

After receiving this good news, we introduced our Club to other associations so that they would know of our existence. We wrote to Mrs. Betty O'Brien of C.F.A. who answered promptly congratulating us and wishing us good luck. Mme. Ravel volunteered to introduce our Club to the G.C.C.F. on one of her many trips to Great Britain. (Cont'd p.12)

SENTY-TWIX

MRS. NANCY HARDY
(GCCF & FIFE JUDGE)

2 CLIFF TERRACE Phone-2884
BUDLEIGH-SALTERTON, DEVON EX9 6JY, ENGLAND

CH. SENTY-TWIX CRISPATIS
TORTIE-&-WHITE FEMALE



Photo by Hill's
Studio, Exmouth

CORNISH REX KITTENS FOR WORLDWIDE FANCIERS

(NO DEVON REX IN OUR BREEDING PROGRAMME)

BLACKS, BLUES, CREAMS, BLUE-CREAMS,
REDS, TORTIES & OTHER COLOURS.

AT STUD:

SENTY-TWIX CRISPATIS
(Cream-&-White brother of Ch. Crispatis)
SENTY-TWIX JASPAR
Typy Cream with superb coat. BEST FOREIGN
SH at HERTS. & MDDX. CH. SHOW, 1973, his
first adult appearance. Son of Ch. Senty-
Crispatis and Amaska Muscatel.

PLEASE SEND INQUIRIES TO
MRS. HARDY OR MRS. HAMILTON

MRS. R. W. HAMILTON
HASKERS, WESTLETON,
SAXMUNDHAM, SUFFOLK IP17 3AP, ENGLAND

ZUREIQA

American Cat Association



Started in 1899,
America's oldest registry

AMERICA'S OLDEST ASSOCIATION NOW BECOMES

AMERICA'S MOST UP-TO-DATE

ALL-AMERICAN ASSOCIATION

ACA'S 1973-74 SHOW RULES NOW INCLUDE:

- * SELECTION OF BEST FIVE CATS IN COMPETITION (REGARDLESS OF SEX);
- * BEST AND SECOND BEST IN COLOR CLASSES, BREEDS AND DIVISIONS;
- * A NEW 100-POINT GRAND CHAMPIONSHIP BASED ON CHAMPIONS DEFEATED;
- * RECOGNITION OF TORTOISESHELL SMOKES & CHOCOLATES AS PERSIAN COLORS;
- * A NEW HIMALAYAN DIVISION WITHIN THE PERSIAN BREED--PERSIAN & HIMALAYAN OFFSPRING ARE ELIGIBLE TO BE SHOWN IN RECOGNIZED COLORS.

ACA CONTINUES TO PROTECT BREEDERS BY REQUIRING FULL STUD BOOK STATUS FOR ALL CATS SHOWN. WRITE TO THE ACA SECRETARY FOR A COPY OF OUR NEW SHOW RULES.

LOUISE (LOU) MURRAY, SECRETARY

16318 LAKEWOOD BLVD., BELLFLOWER, CA. 90706

ZIG-KRN

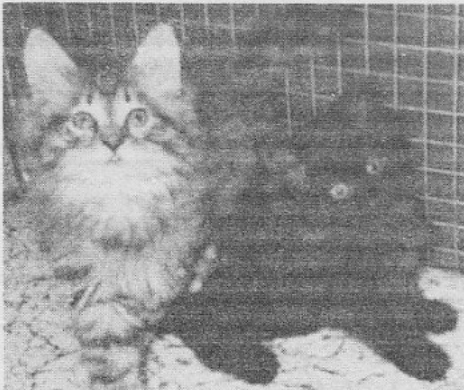

KITTENS BY DBL.CH. ZIG-KRN'S PEGASUS (1973 All American & All Western Blue-Eyed White) & DBL.CH. ZIG-KRN'S PRETTY GIRL (1973 All Western & BOX All American Brown Tabby).

**KITTENS NOW AVAILABLE FROM
1973 ALL AMERICAN BREEDING**

ZIG KOZACZKA

Phone 602-833-1923

P.O. BOX 72, MESA, ARIZONA 85201 USA

FIRST CAT SHOW

Our first cat show was held on August 12, 1973, in the Jardim da Luz, Sao Paulo, Brazil. The Club has little funds--more goodwill than money--so the Secretaria de Turismo e Fomento do Municipio de Sao Paulo offered a place where we could hold the show without charge.

Mme. Ravel judged the fiftyone cats who were entered in the Primeira Exposicao Internacional De Gatos Do Brasil, including four who came from France. Entries included Persians (Copper-Eyed White, Blue, Cream, Blue-Cream, Silver Tabby and Chinchilla); Birmans; British Blues; and Siamese (Seal Point, Blue Point and Chocolate Point).

Ten Certificats d'Aptitude de Championat were awarded. Chosen International Longhair was VLADIMIR DE POUH-MILOH, Birman owned by Mr. and Mrs. de Pindray, France; International Shorthair was ISIS DE CHENONCEAUX, Seal Point Siamese owned by Mr. Claudio Gornatti. National Longhair was SUNNY, Susanna Jank's White Persian, and National Shorthair was my Siamese Blue Point, LAENRHE. Both of the National winners have only initial registration.

Our first show was a great success even though not all our cats have pedigrees but are only registered in the experimental stud-book in France.

FOUNDING OF MORE CLUBS

This phase is still under preliminary study but seeds have already been planted. We have had an opportunity to exchange ideas with other Brazilian states on what will be necessary for the formation of more clubs so that they may obtain our recognition and that of F.I.F.E. We will be proud to help other states or South American nations on this work.

EDITORS' PREAMBLE (CONTD. FROM P.3)

sian male, INT.CH. CLOUGH AQUARIUS, bred by Mrs. Thorpe. This 3-year-old has won three Challenge Certificates in England and Scotland and three from the G.C.C.F., Ireland.

CAT WORLD ADVERTISING PLEASURES

Aryline Strobel, Sungold Burmese, wrote us: "To say that I am pleased with my display ad in the September/October issue is the understatement of the year. I am simply delighted! Thanks for doing such an excellent layout job on the material I sent. I think I have finally found a source for advertising I like and can afford." Other advertisers have sent similar comments.

Deadline for the January/February issue is Friday, December 7. Why not plan a regular advertising program for your cattery for 1974? With CAT WORLD's special 'breeder-affordable' rates (p.35) the cost is surprisingly low.

We would be delighted to design an attractive advertisement for you. Just tell us the size, what you want to say, and send any photos to be included. We'll do the rest. It's that easy to put YOUR CATTERY in the CAT WORLD showcase in 1974! ###

Veterinary Views

VETTING-IN

BY JULIA M. MAY

At present, the show regulations in Great Britain state that all cats must be inspected by a veterinary surgeon on arrival at the show before being admitted to the exhibition hall.

This inspection entails an examination of the cats for any signs of infectious or contagious disease, checking to see that queens are not obviously pregnant or lactating, that entire males have all their equipment (monorchids and cryptorchids are admitted up to nine months of age), and that no cat has been declawed.

The cats' mouths are examined for ulcers, noses for signs of discharge, and eyes for conjunctivitis; their lymph nodes are palpated as enlargement may be a sign of infection. The ears are examined, if necessary with an auriscope, for signs of ear mites, and coats are checked for fleas, mange and ringworm.

If there are no specific signs of illness but the cat does not look right, its temperature may also be checked. It takes very little time to examine a well-behaved cat in tip-top show condition but, if a cat has not been prepared for a show, the examination can be lengthy.

PREPARING FOR SHOW

Show preparation can be divided into two parts: firstly, looks and health, and secondly, behaviour. Preparation of looks and

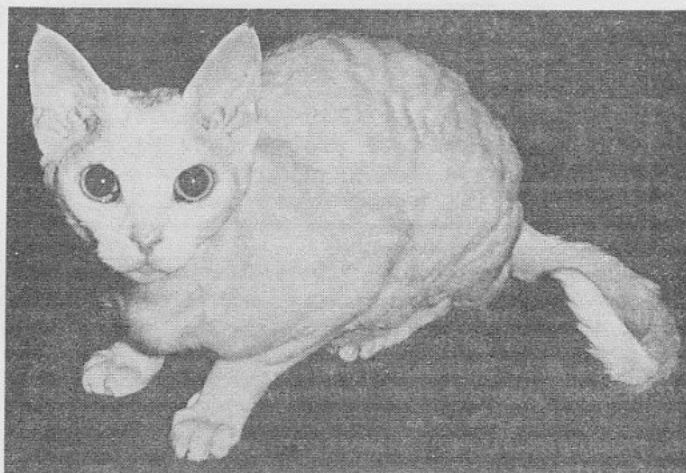

CH. BERILLEON PRINCESS PIXIE, 3-year-old White Devon Rex female, bred by Mrs. B. Lyon and owned by Mrs. D. Banfield. She is one of the 1973 'Great Cats of Gt. Britain'.

health should be almost unnecessary as the cat should always be in good health and be groomed regularly (the amount required obviously varying with the breed), so the only preparation required before a show would be a little extra grooming and a check to make sure that ears, eyes, nose and mouth are clear.

Unfortunately, I see too many cats which arrive at the show dirty or unhealthy: their ears are waxy and mite-infested, they have fleas (not just the odd one which can be picked up in the queue, but many, together with dirt in the coat), or they may have a purulent discharge from the eyes or nose. These conditions are sometimes so severe that they could not possibly have been missed had the cats been checked over prior to the show. The assumption must be that the owner does not care; but why bring them to a show? Not

(Continued on page 30)

PRAHA BIRMANS (SACRED CATS OF BURMA) & Red Self Persians

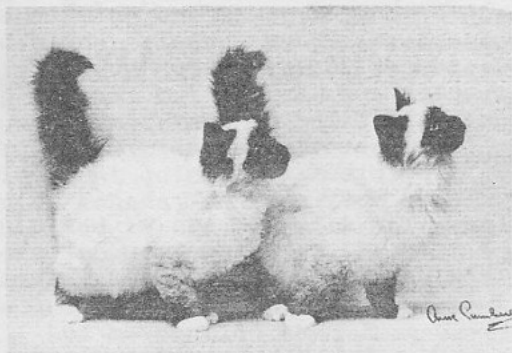

KITTENS SOMETIMES AVAILABLE

STUDS:

Fee by
arrangement.

CH. PRAHA SIK-KIM (SEAL)
RESERVE BEST IN SHOW, WINNER OF COYLUM CUP.
GD. CH. PRAHA HU-TSUNG (SEAL). BEST IN SHOW, 1970.
CH. PRAHA MICHEL (SEAL). 4 C.C.'s.
YOUNG OUTCROSS STUD NOMINATED FOR BEST IN SHOW.

D A M S

CH. PRAHA CHUMAR - NOMINATED FOR B.I.S., 1973
CH. PRAHA SHAWNEE (SEAL). B.I.S., BEST EXHIBIT, 1969
CH. PRAHA KRAPING (SEAL). BEST KITTEN, 1969.
CH. PRAHA MI WA (SEAL). 5 C.C.'s.
CH. PARANJOTI KATMANDU (BLUE).
CH. PARANJOTI CHIMEA (SEAL).
CH. OSAKA DE LUGH (BLUE).

PRAHA CHAMPION WINNERS:

INT. CH. PRAHA SHAWNEE, INT. CH. PRAHA SINGH, INT. CH. PRAHA HUI-TSUI, INT. CH. PRAHA TA-HO, INT. CH. PRAHA KANNO, INT. CH. PRAHA AMRITA, All-American Mid-Western Best in Show Birman Female, INT. CH. PRAHA KHOLA, Best All-American Birman Male, INT. CH. PRAHA RINGLING, Best All-American Female Birman, GD. INT. CH. PRAHA HU-TSUNG, CH. PRAHA MANTRA, GD. CH. PRAHA HOA MAI, GD. CH. PRAHA TAN PHAT, CH. PRAHA SIK-KIM, CH. PRAHA CHEN YU, CH. PRAHA KRAPING, CH. PARANJOTI KATMANDU, CH. PARANJOTI CHIMEA, CH. PRAHA SHIVEY MU, CH. PRAHA MI WA, CH. PRAHA KIOWA, CH. PRAHA MICHEL, CH. PRAHA KITTAH (Blue), CH. PRAHA KHAME, CH. PRAHA SHIVEY MOW, CH. PRAHA CHUMAR.

Mrs E FISHER

47 MARLBOROUGH
MANSIONS,
CANNON HILL,
LONDON NW6 1JS
ENGLAND.

PH.: 01-435-0760

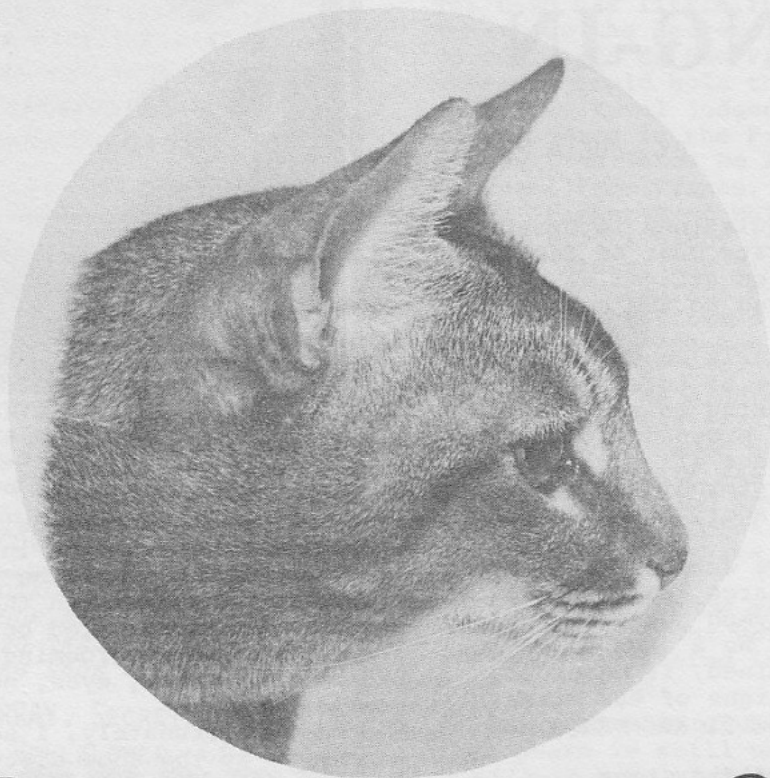

Reminiscences Of Rameses

THIS STORY HAS BEEN WRITTEN BY KIM EVERETT AS A SPECIAL TRIBUTE TO ONE OF
THE GREATEST CATS OF ALL TIME, GR. CH. PHAROH RAMESES II, 'BIG RED'.

Up to 1963, I had had Siamese and Persian cats but had long been fascinated by the Abyssinian and, as fate would have it, I was destined to be 'owned' by one of these cats of wild and outwardly regal appearance.

In the wee hours of the morning of September 26, 1963, the cat was born, along with four sisters and brothers. He was a very unusual, beautiful male kitten with the deep and glowing color of an Irish setter all over but for a little black skull cap. The other kittens in this, our first litter of Abys, were very dark as are most Aby kittens from this line. The litter was also a 'first' for both parents, *RING'S ABI TANJII OF PHAROH*, and sire *CH. PHIL-SARI'S KI-O-KIZAN OF PHAROH*.

At four days of age, we placed this beautiful little boy on a pale yellow pillow to take color photos. He held his head high and listened to all sounds around him. His eyes were not as yet open but he showed no fear of anything.

Next thing was the selection of a name befitting such a princely kitten. I decided that for our first Aby a very royal name should be used and, thus, *PHAROH RAMESE II* was christened. This would be the only Egyptian name we would ever use since he would be king of our future Abyssinians.

Several breeders came to see the tiny fellow and remarked he must be a mutation because of his coloring! Of course he was not a mutation but was closely line-bred from his grandsire, *TRIPLE GRAND CH. ABDEL*, who also possessed the beautiful eye-catching color with jet black ticking and lovely coat.

SHOWING RAMESES

We started *RAMESES* off to his first shows as a kitten at 4 months. To our delight he went **BEST KITTEN** in the All Breed rings and showed just as though he knew what it was all about. He went on to be top 1964 kitten in his Region that year.

His love of shows, plus the encouragement from fellow breeders and exhibitors, prompted us to go forward with him. His first year, 1965, he hit the show circuit as an adult and was dubbed *BIG RED* by his many fans. The name stuck and he was from that day called *RED*.

That year we flew with him throughout the country taking many **BEST CAT** awards along the way. *RED* had a true love of the showing and of being handled and oooed and aaahed at. At season's end he was awarded the title of **ALL AMERICAN SECOND BEST CAT** losing by only about three points to a Silver Tabby American Shorthair. That year, all U.S. cat associations were competing in the All Americans.

The new season for 1966 rolled around and *RED* really blossomed. He was at his peak in all respects with his marvellous disposition remaining the same. *RED* was ready --- I was ready --- and we decided to go all out and attempt to make **ALL AMERICAN CAT OF THE YEAR**, 1966. This took a great deal of planning and preparation. First, every show and association was checked as to dates, location and plane points. We have never picked any certain few judges taking what came in that department, but *BIG* shows were a must as it is most important to hit the shows with the largest entries in order to get the points. This meant going to shows in the East and South, Canada, the West and the Midwest. We exhibited in CFA, ACFA, ACA, Crown and CCA shows, some of which reached 600 cats in the Championship classes. There was no limit and the quality was terrific.

Let me mention that that particular year *SHAWNEE WHITE WASH*, *JENKIN'S DARK HUSSY*, *G(LEN)N'S GERONIMO OF ROGERS HTS*, *MAKHANDA WILLA*, *MIZPAH'S FERDINAND OF BRIERWOOD* and

Aristock Cattery

MRS. BARBARA BOIZARD
BRABANT FARMHOUSE, TRINITY, JERSEY
CHANNEL ISLANDS, U.K.
Telephone - NORTH 1487

Burmese Kittens

NOW AVAILABLE FOR SHOW & BREEDING

- EXCELLENT TYPE -
- FRIENDLY TEMPERAMENTS -
- BRITISH & AMERICAN BLOODLINES -
- CAREFULLY BRED FOR HEALTH & STAMINA -
- WILL SHIP TO MOST COUNTRIES -

WE SPECIALIZE IN LILACS & CHAMPAGNES.
I WOULD LIKE TO CORRESPOND WITH BREEDERS
EVERYWHERE WHO ARE INTERESTED IN WORKING
IN A PROGRAM FOR THESE BEAUTIFUL COLORS.

Bambino Burmese

Tired of high-strung, noisy Siamese?

Try our beautiful, quiet EGYPTIAN MAU!

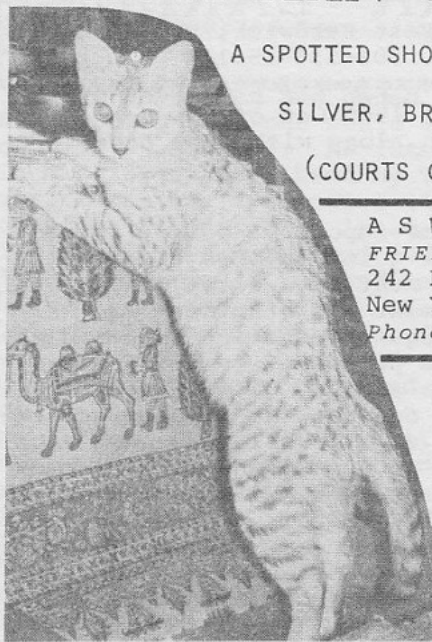

A SPOTTED SHORTHAIR IN

SILVER, BRONZE OR SMOKE,

(COURTS CHEVEUX TACHETÉ)

ASWAN CATTERY
FRIEDA ST. SAUVEUR
242 E. 15
New York, N.Y. 10016
Phone - MU3-3145

FATIMA
CATTERY
PRINCESS N.
TROUBETSKOY
240 E. 30
New York, N.Y.
10003

Phone - GR3-5268

EARROS Cattery

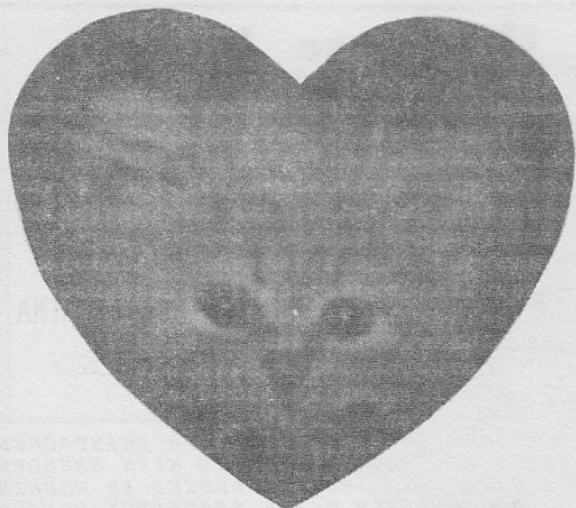

PERFECT PRINCESS SUPERAYSE (Cameo)

LUXURIOUS PERSIANS &
AUTHENTIC TURKISH ANGORAS

SHOW AND BREED QUALITY

SILVER VARIETIES, BLUE, CAMEO

COPPER- & BLUE-EYED ANGORA

(See "Peruse & Choose"--Multiple)

DEBRA EARLE

P.O. Box 8, East Hardwick, Vt. 05836
PH. 802-533-2561

SHAWNEE TRADEMARK, 1965 Cat of the Year, were all in competition along with many other tremendous cats.

DESIRE TO WIN

There are some important points to consider when you are going to show a cat this extensively. You must have a top quality cat with both temperament and stamina. *BIG RED* fulfilled these requirements and also had the desire to win. He performed for the judges, flexed his muscles and his glowing coat---few could resist! At one show he somehow got out of his exhibition cage. Where was he? Right up on the nearest judge's table in the middle of another class ready for his turn!

During his show career, *BIG RED* picked up a number of traits one of which was to not let a judge forget he was there just in case they were thinking over some other Abys in the class. He would put his paw out of his cage and be very boisterous and vocal until

the judge would come back to look at him again. He would then strut around and beg to get back on the table for more detailed inspection. He would pose, race over and loved being sailed through the air, stretched and whatever. I think that one of the nicest tributes to any cat and especially for our guy was that breeders of both Shorthairs and Longhairs loved him.

RED always looked and performed best when I would go to shows with him. He would step out on to the judge's arm and go to the table, quickly look for me and, once getting me in his sight, was ready for the spotlight. We seldom agented him and, unless it was someone he knew and communicated with, he would sit and sulk in the judge's cage. Several judges commented on this and how he pouted.

Another little trait he picked up that year was spraying the audience and, sometimes, even the judge! 'Accidentally', of course, if they were in the line of fire. This may be unbelievable to those who never saw *RED*, but he was a great one to case his audience while the judge was busy looking the class over and then he would actually smile, turn around and the audience would go running in all directions! What fun he had. He also discovered that he was not limited to straight ahead situations but could also make his mark at nearly a 90-degree angle and send the rest of the males in the class wild. This really delighted him. *RED* was never upset around other males and often the judges would put him out on the table and bring another male out with him. At one show a very famous Chocolate Point male was caged next to him during the finals and reached over and clouted *RED*. Well, no one was going to get away with this so he stood up and gave the handsome Chocolate Point a good nip on the ear, sat back down and was ready to receive his wins.

RED would amuse the audience while waiting for the judge to place the rosettes and trophies. He would tilt his head up and watch the top of his cage actually expecting the awards. (I might mention here that *RED* was never caged at home and was a true household pet to us. He lived with the family and did not have the usual male habits at home.)

On Saturday evenings at the shows we would occasionally use him for breeding with females who just happened to be interested. This saved them a trip out to Oregon and *RED* would go right back to the show on Sunday none the worse for wear and, most of the time, win BEST CAT awards.

RED had his own special shipping carrier all lined with carpet. It had a pillow which could be heated by a battery in cold weather. He had an assortment of car coats which kept him warm, too. Always, when making reservations, I would check on facilities for cats and nothing would be too good for him. He stayed in my room, had television going and liked his bed cover rolled back---I could get

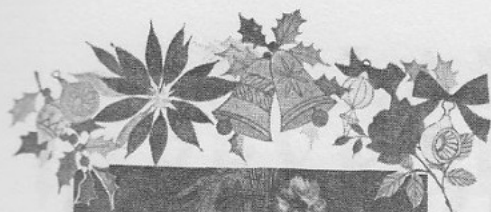

Merry Christmas

CFA

Photo by Janet

KITTENS FOR SALE:

*
2 BLUE POINT MALES
1 BLUE POINT FEMALE
*
SERIOUS INQUIRIES
ONLY, PLEASE.

STUD SERVICE
ON SELECTIVE BASIS ONLY.

ERIC & SUZY ROCKSTROH

228 Nottingham, San Antonio, Texas 78209 USA

—Breeding with integrity for quality.—

ERIK-**A**-SU
CATTERY

ACFA

WE WOULD LIKE TO EXPRESS
OUR GREATEST ADMIRATION OF:

MRS. S.M. HARDING
*** MINGCHIU CATTERY
HUGH & MARY OLANDER
*** HO-CO-MO CATTERY
BUTCH & HEIDI NODDIN
*** BADI CATTERY

(512) 828-0103

in, too. RED always slept with his head on the pillow and liked to have the covers over him. His favorite foods and bottled water were taken to the shows so as not to take him off his regular schedule. Most important, he received all his usual love and attention.

At the conclusion of the 1966 season, after competing in 36 shows (144 rings), GR. CH. PHARO H RAMESES II was named ALL AMERICAN CAT OF THE YEAR by a huge point margin. He had succeeded in going from Number Two to Top Cat. He was, and still is today, the only Aby ever to do this. His relatives have placed high in different associations' national awards including Second Best Cats but never Best Cat. BIG RED contributed much to his breed by this achievement and this was more important that the thrill it gave us.

In 1967 we showed RED only moderately without pushing him but he still went THIRD BEST CAT and Best All American Abyssinian for the third straight year. After that he was retired.

The approximate cost of showing RED and, later, CITATION, was \$8,500.00 for a full show season. Living on the West Coast, it is a long way to travel to the Midwest and East Coast shows.

RETIREMENT

RED missed the shows and when we would get one of our other cats ready to go he would run over to the carrier and want to go, too. We put him on exhibition a few times at local shows which he loved. At a Washington show, he lazed on top of his cage on my coat and greeted all the people. He loved being handled.

Nearly a year of his retirement went by. Just short of his fifth birthday, he was taken to the vet for his annual teeth cleaning. Our vet of many years gave him anesthetic to scale the tartar from his teeth. Suddenly he stopped breathing. They tried everything but to no avail. Our vet was beside himself as

he knew how much this cat meant to us. It was a terrible shock and we spent many sad weeks from that day. It was determined that RED had cancer of the liver which was why his breathing failed under the anesthesia. The unusual part, our vet said, was that he had had no indication of any illness and, in fact, had bred a visiting female the day before he died.

On hearing the news, cat fanciers and judges from all over the country who admired this great cat sent flowers and cards. I was about to give up cats after losing this wonderful friend and companion who had given us so much pleasure. We made arrangements for his burial in a silk-lined walnut casket in our garden. A marked headstone was made and azaleas planted all around. This may seem rather ridiculous to some but, to us, this great cat deserved something special.

'JUNIOR'

To have bred and owned such a cat as BIG RED is more than one would ever hope for but once in a lifetime. As fate would have it, in his last litter bred by Ted and Mary Stegant, there was a gorgeous little female among the four kittens with 'that look' about her. Two well-known All Breed judges in Houston, Texas, saw the litter and immediately picked her out. Since a repeat of the breeding had been done the day prior to RED's demise, Mary and Ted phoned and offered this kitten to us.

We gratefully accepted this baby. Her dam is CH. PALLADY'S PAT so her other half also has a line of top quality cats. We had received many pictures of her and she was everything and more than we dreamed of. Her name? JUNIOR, of course, after her famous sire! Her registered name is TEMAS PRIDE OF PHARO H as she was the pride of both the Stegants and ourselves. Not only did she possess the class and glamor but her showmanship and temperament were so much like her daddy's.

(Continued on page 30)

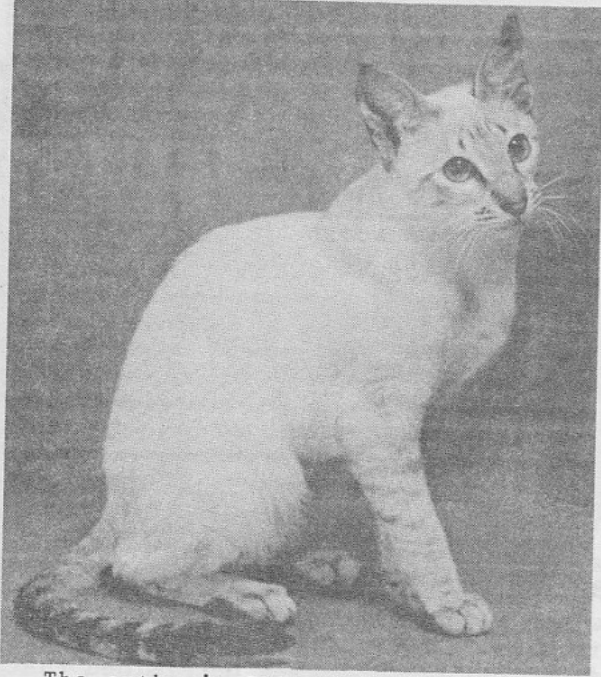

The author's PRESTWICK PERVENCHE, female, bred by Mrs. Hindley.

I was helping at the Croydon Cat Club Show in London in 1961 when I became aware that my friend, Mrs. Greta Hindley, was beckoning to me. I went over to her and she seemed very excited. "Come and see what I have found," she said. "I know it is naughty of me, but I have bought one." Highly mystified, I followed her to a cat pen and there were some beautiful Siamese kittens sitting looking at me or were they really Siamese? They didn't look quite right to me. They had brilliant blue eyes, pale coats and solid ears, but with tabby markings on their little faces, legs and long, ringed tabby tails, yet with the most superb Siamese type. I was not surprised that such a well-known and experienced breeder of Siamese as Mrs. Hindley was so impressed.

The breeder of these kittens, Miss Eileen Alexander, then told me her story. In 1960 her Sealpoint Siamese queen, *LADY ME*, had slipped out and found her own mate. Immediately on her return she was mated to Mrs. Buttery's Sealpoint, *DRUID*, and one of the kittens in the litter from this dual mating was a Tabbypoint female, *PATTI*. Because of her attractive and unusual appearance, Miss Alexander had her mated to Mrs. Buttery's Sealpoint, *SAMSARA SARASON*, and these were their kittens. The four Tabbypoints were so similar and well marked that Miss Alexander thought it seemed a pity not to introduce them to the cat fancy and so she got permission from Mrs. Towe to bring them to this show. Mrs. Hindley upon seeing them realized how attractive they were and bought a female, *TANSY*.

From these beginnings have grown the ever increasing Tabbypoint Siamese. Soon

The TABBYPOINT SIAMESE

BY NANCY HARDY

JUDGE, GCCF & FIFE

word came of another litter sired by *SPOT-LIGHT TROUBADOUR*, a Sealpoint belonging to Mrs. Warner, and *MISS TEE KAT*, owned by Mrs. Bennett. Mrs. Hindley, Miss Alexander and I went to see them and bought *MISTER BUTTONS* as an unrelated mate for *PATTI*. Here we met Mrs. Warner who had taken a female, *PRALINE*, the foundation of her beautiful Tabbypoints.

The name for these cats gave rise to much controversy as 'Tabbypoint' was considered rather too ordinary for such lovely type Siamese cats. A Club was formed and the name 'Lynxpoint' introduced; this is still used in U.S.A. and some parts of Australia, New Zealand and, I think, Canada. As several breeders disliked this name and it was thought that the G.C.C.F. might not accept it because it is the name of another animal, Mrs. Hindley asked me to help her start another Club. This we did in 1964 and, at the inaugural meeting, it was decided to call the cats 'Tabbypoints' and to add 'Progressive Breeders' to the Club's name. Later on, the name 'Attabiy' was voted for, being the original name for the tabby cat in Persia, but this led to impolite noises such as 'Atta-boy'. Then 'Shadowpoint' was chosen and our Club became the Shadowpoint Siamese & Progressive Breeders Cat Club.

What a time we had getting these lovely Siamese-type cats recognized and our thanks go to Mrs. Hindley for her courage and tenacity in doing this. Finally, the Siamese Cat Club Committee, of which Mrs. Hindley and I were members, decided that these cats should be called Tabbypointed Siamese but that they should not be classified with the solid pointed Siamese. It was decided to give them a different Breed Number to distinguish them as variegated pointed Siamese, for what is a Siamese? To quote Jude: "A Siamese cat is a foreign-type SH cat with blue eyes and colour restricted to the points".

In 1966 these cats were granted recognition by the Governing Council of the Cat Fancy and given the name 'Tabbypointed Siamese,'

(Continued on p.24)

ENGLAND'S TABBYPOINTS

BY BRUNETTE GREENLAND

The majority of England's really good early Tabbypoints were bred by Mrs. Richard Warner out of her Tabbypoint queen *PRALINE* (CH. *SPOTLIGHT TROUBADOUR* X *MISS TEE KAT*), founder of the Spotlight strain of Tabbypoints, and her Sealpoint stud, *WHITEOAKS MALAHIDE*. The very first Tabbypoint Champion came from this mating, *CH. SPOTLIGHT PENNYLYNX*, a superb specimen of the breed.

Other well-known Tabbypoints from this mating are: *SPOTLIGHT RICKY-DICKY*, *CHANTILLY*, *INT.CH. SPOTLIGHT FRANKINCENSE*, and *BURLINKS*.

A specialist Club for Tabbypoints was formed in 1964 at a meeting in Mr. and Mrs. Warner's home in Sevenoaks, Kent. The Club was first named the 'Lynx Pointed Cat Club'; however, when 'Lynx-Points' were given their full recognition in 1966 and became 'Tabby-Pointed Siamese', the Club became the 'Tabby Pointed Siamese Cat Society'.

When Mrs. Warner's beloved *PRALINE* departed this life, her lovely daughter, *CH. SPOTLIGHT PENNYLYNX*, took over the production of the Spotlight Tabbypoints. *PENNYLYNX*, in my opinion, gave England it's greatest female Tabbypoint to date, *CH. SPOTLIGHT KOPEIKA*. This enchanting cat was sired by that lovely Bluepoint, *CH. MACEDON MARQUIS*. *MARQUIS* was bred by Miss Alexander and owned by Mrs. Hudson of the Supra Cattery.

KOPEIKA gained her title in three consecutive shows. She was highly acclaimed and gained Best-In-Show awards amongst her many achievements.

My husband and I commenced breeding Tabbypoints in 1967 under our prefix 'Moonfleet'. We purchased a lovely Lilacpoint queen from Mrs. Angela Sayer of the Solitaire Cattery called *SOLITAIRE MICA*. In due course, *MICA* was bred to *SPOTLIGHT PETIT BURLINKS* and from this union we produced two lovely Tabby-

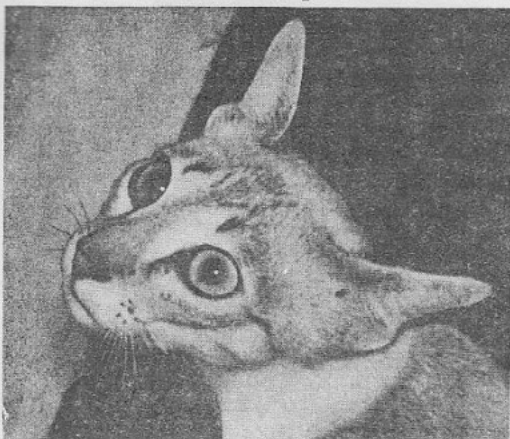

Mrs. Warner's famous queen, *PRALINE*.
M. Warner photo

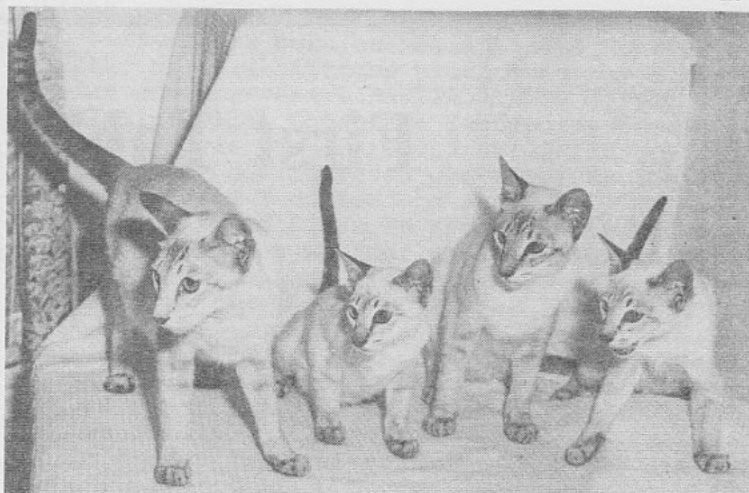

CH. SPOTLIGHT PENNYLYNX, *SPOTLIGHT OTTERLYNX*, *INT. CH. SPOTLIGHT FRANKINCENSE* and *SPOTLIGHT RICKY-DICKY* bred by Mrs. Warner. *D. Davis photo*

points, *MOONFLEET AQUILA* and *MOONFLEET MICA'S ARIES*. We repeated this mating several times and produced numerous quality Tabbypoints and a superb Sealpoint which we called *MOONFLEET AURIGA*.

AQUILA, bred to *SPOTLIGHT KIRIDOM*, produced *MOONFLEET JUPITER*, a Seal Tabbypoint of superb type who gained the most points at shows as a kitten last season and was awarded the 'Starfall Cup'. *KIRIDOM* is a Bluepoint son of *CH. SPOTLIGHT KOPEIKA*. (Cont'd p.23)

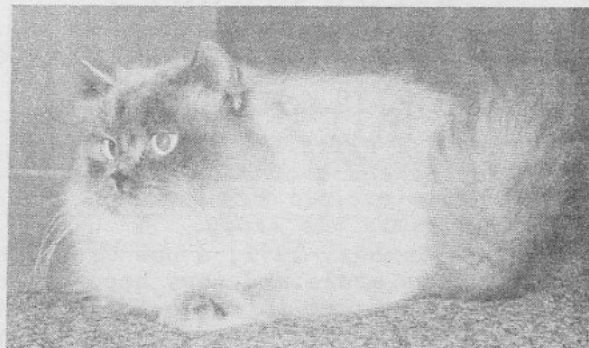

D
A
L
E
N
E
S

P
R
E
C
H
I
L
I

DALENE'S HIMALAYANS

... from choice bloodlines;
... lovingly home-reared;
...carefully bred for purrfect temperaments and Persian type.

THEY LOVED US ... NOW WE HAVE SOME READY TO LOVE YOU.

PET - BREEDING - OR SHOW QUALITY IN BLUE, SEAL, CHOCOLATE, LILAC/FROST POINTS.

Proven Adults Occasionally
..... Self Colors Sometimes

-STUD SERVICE LIMITED TO APPROVED QUEENS-
SERIOUS INQUIRIES WELCOMED.

GRACIE O. McCARTY PH. 512-924-3392
511 WARE, SAN ANTONIO, TEXAS 78221 U.S.A.

First Tabby (Lynx) Pt.

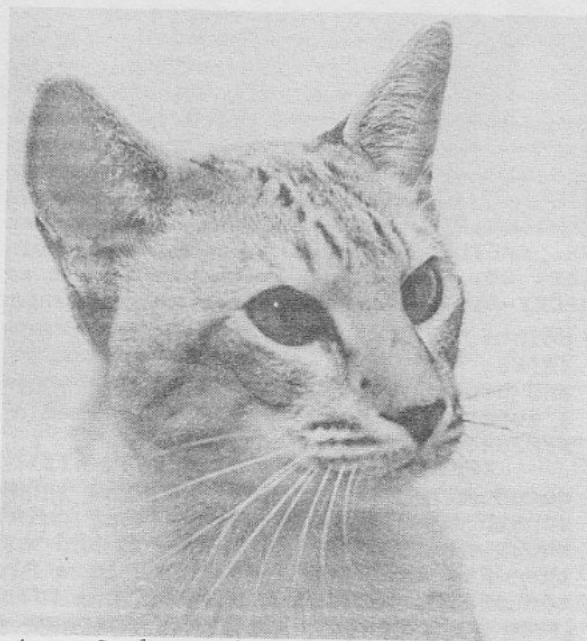

Anne Cumbers photo

Seremban Liger

G.C.C.F. (U.K.)

LIGER is Britain's first Siamese Grand Champion and second cat of any breed to win this title. His breeder, Mrs. Anne Aslin tells his story.

In September, 1972, a new Grand Champion was acclaimed thus becoming only the second cat in England to win this title. *SEREMBAN LIGER*, Seal Tabby-point Siamese, was awarded his third Grand Challenge Certificate by Mrs. Clark at the Herts. & Middlesex Championship Show. England's first cat to become a Grand was Mrs. Absalom's British Blue male, *BRYNBUBOO LITTLE MONARCH*. (*CAT WORLD*, March/April 1973)

KOUNTRY BOY (photo below) is the first American-bred Lynx Point to become a Grand Champion. His story is told by his breeder, Mrs. Pat Collins.

We bred our first Lynxpoint Colorpoint Shorthair in 1966. She was the result of a mating between our Siamese queen and a Silver Tabby half-Siamese male. At that time we were not showing cats or even really aware of cat shows, etc., but since she was such an attractive cat we decided to keep her. To our surprise and delight, this one kitten from the litter began to color up from

Kastl Rock Kountry Boy

C.F.A. (U.S.A.)

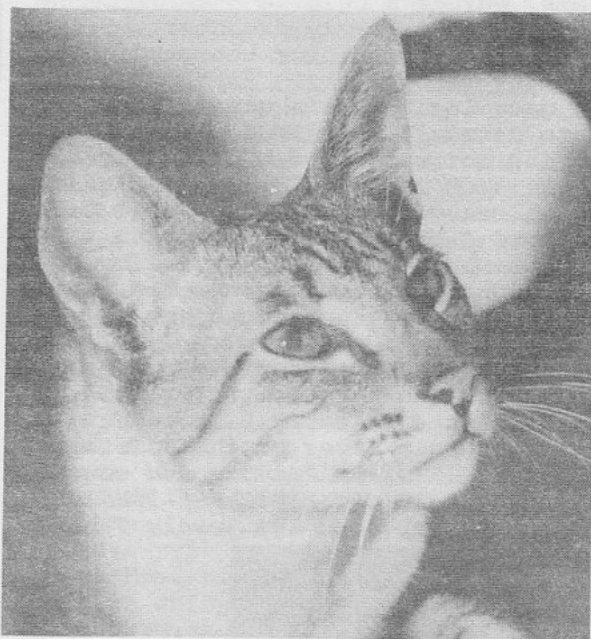

Grand Champions

KOUNTRY BOY

her newborn pristine white and develop stripes on her tail and face rather than the sooty black or blue that we were used to. We decided to call her a 'Silverpoint' and later bred her to our Siamese male which produced another female 'Silverpoint'. This cat, in turn, was bred to a Siamese Sealpoint male and we had our first male Lynx.

After reading an advertisement about a cat show, we called the number and got in touch with Mrs. Kim Everett who encouraged us to show the male as a kitten. Although he had beautiful coloring and a fine short coat, long legs and body, he just did not have quite the Siamese head that he should. At the show we met a lady who had some Lynxpoints that she had bred as a hobby for years but she called them 'Polynesians' for her original pair had come to her from Hawaii. We bought her three remaining females and our next step was to buy a Sealpoint Siamese stud, YAMA'S SIGISMUND OF MIJIRI, a cat with a fine pedigree who throws lovely kittens.

Still learning, we bred SIGI to the best of the three queens, SU LANI TU OF KASTL ROCK. When the litter was born on July 2, 1971, we instantly knew that something was different. These four kittens were the boniest, longest, ugliest Siamese that we had ever seen; nothing cuddly and cute about them. The ugliest one, of course, was KOUNTRY BOY. The whole litter was show quality with flyaway ears and each of them has since made finals in shows.

We entered KOUNTRY BOY and his sister, KOUNTRY GIRL, in an ACFA show as kittens. KOUNTRY BOY was Second Best Kitten and Best Siamese Kitten, while his sister was Best Siamese Kitten Opposite Sex (BOX) in Mrs. Belk's Shorthair ring. Then they went on to be Best and BOX Siamese Kitten under Mrs. Chapman who also awarded KOUNTRY BOY Best All Breed Kitten! This set the showhall on its ear because it was unheard of for this to happen. This was his starting point and he has never stopped. He made his C.F.A. Grand Championship in only four shows, very good for a Colorpoint.

He made his A.C.F.A. Grand Championship in three shows, becoming that association's third Lynx Point Grand. (Editors' note: The first two were English imports, Hihoe Curacao of Bon-Jon, bred by Mrs. Dack and owned by Mr. and Mrs. John Berry; and Solitaire Dimity of Mt. Sunrise, bred by Mrs. Sayer and owned by Mr. Dawayne Goodburn. Both are females.)

KOUNTRY BOY is a good-sized cat and very well-balanced. He has huge ears that set well down on his head and finish his wedge to perfection. He has long legs and body and a long whippy tail. His most striking feature, perhaps, after his head and ear set, are his eyes which are the very deep vivid blue. He is a gentle, sweet-natured boy and has never given us nor any judge a moment's trouble during his rather strenuous show career. (Cont'd)

LIGER

LIGER was born on May 15, 1969, one of a litter of three kittens produced by my Bluepoint queen, SUPRA LARKSPUR. Sire of the Sealpoint male, Chocolate Tabbypoint female and LIGER was CH. SPOTLIGHT SEIGFRIED.

At the age of seven weeks, LIGER really stood out and I decided to show him. He won his Open Kitten Class at the Herts. & Mddx., 1969, and at the West of England Show in November, 1969, he won his Open and was also Best Kitten In Show.

In his seventh and eighth months, LIGER was quite ungainly with big feet and paws and a lot of puppy fat, a typical adolescent but we were not discouraged. His first show as an adult was the 1970 Notts. & Derby. Cat Club Show. Judge Miss Rickson awarded him his first Challenge Certificate. His second C.C. was given to him by Mrs. Dadd at the Southern Counties Show in 1971 while the one which made him Champion was awarded by Miss Codrington that same year at the Suffolk & Norfolk Cat Club.

LIGER did have some near misses as he competed for his Championship but, as he matured he seemed only to improve yet still retaining his unmarked coat, and was undefeated in his quest for his Grand Championship. Dr. Groom gave him his first Grand Challenge Certificate in 1971 at the Siamese Cat Club Show; Mrs. Kent the second in 1972 at the Siamese Cat Association Show; and Mrs. Clark

TABBYPOINT & PROGRESSIVE BREEDERS CAT CLUB

A SPECIALIST CLUB FOR TABBY POINT SIAMESE,
ALSO A.O.V. SIAMESE AND SIAMESE TYPE S.H.
ACHIEVING RECOGNITION AFTER MARCH, 1973.

PRESIDENT:

MRS. HINDLEY
CHAIRMAN:

MRS. NANCY HARDY

HON. SEC.:

MISS GAMBLE

THE LODGE,
FARNINGHAM HILL,
FARNINGHAM, KENT,
ENGLAND.

HON. TREAS.

MRS. HUNT,
23 COPPHILL LANE,
BUDLEIGH SALTERTON,
DEVON, ENGLAND

SHOW SEC.:

MRS. K. BURGESS,
31 BALCASKIE ROAD,
LONDON, S.E.9,
ENGLAND.

AFFILIATED TO
THE G.C.C.F.



Subscriptions:
50p per annum

Vari-Kennel

Convertible Pet Apartment

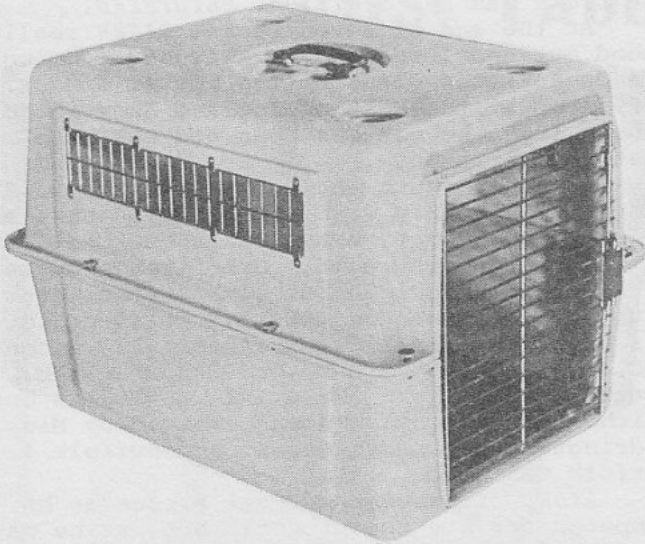

DO YOUR CATS DESERVE THE BEST?
For complete information write:

DOSKOCIL MFG. CO., INC.
DEPT. CW

P. O. Box 1246 • ARLINGTON, TEXAS 76010

I
R
I
S
H

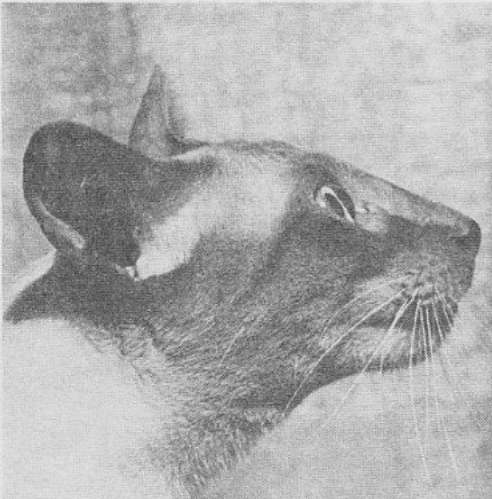

W
H
I
M
B
L
E

SIAMESE BLUEPOINT AT STUD; \$125

SUPERB HEAD, MAGNIFICENT PROFILE,
DEEP EYE COLOR, PROLIFIC BREEDER.

Registered:

IRISH CAT FANCY; CFA (not yet shown);
ACFA (Dbl.Ch.); CFF (Ch.).

From finest English, Irish bloodlines:
English Ch. Winceby Valentine, Ch. Supra
Periwinkle, Ch. Macedon Marquis, Killdown
Kerry.

Direct Inquiries To: MARY LOU SIMMS,
3 LAKE SHORE DRIVE, WATERVLIE, N.Y. 12189

LIGER

awarded him the all-important third one.

In her judging report, Mrs. Clark wrote: "I have always admired this cat from a kitten and I believe I gave him his first prize and sent him for best in show three years ago. I was pleased to complete his show career and make him our first grand champion. He has the real Siamese oriental look, exquisite coat texture, long well-ringed tail, fine bone and what is so necessary in a stud cat a delightful and equable temperament. He was also best in show Siamese."

GR.CH. SEREMBAN LIGER passes his second-to-none nature on to his families. The kittens are gentle, always purring, loving to be touched and cuddled at all times. Exceptional progeny from LIGER to date are BAYARD AKHENATEN, Seal Tabbypoint male, CASMEN LIVIA, Seal Tabbypoint female, and REOKY PEDRO, Chocolate Tabbypoint male, all of whom have two Challenge Certificates to their credit and should become Champions at their next shows. Promising kittens include REOKY DORRETA, Seal Tabbypoint, MOONFLEET OLYMPUS, Seal Tabbypoint, and MOONFLEET ONDINE, Lilac Tabby point, plus quite a few up-and-coming litters from very nice queens.

LIGER's dam was bred by Mrs. Hudson, to whom I shall always be grateful; his sire, bred by Mrs. Warner, is now a much-loved Neuter owned by Mrs. Sylvia Horan.

England's first Siamese Grand Champion is now 4½ years old. With the few select queens he has and lots of love from me, I only hope he will live forever.

GR.CH. SEREMBAN LIGER

Sire:	CH. SPOTLIGHT	Grandsire:	SPOTLIGHT PETIT
	SIEGFRIED, Sl.Tby.Pt.		BURLINKS, Seal Tby.Pt.
		Granddam:	SAMSARA SIVA, Seal Pt.

Dam:	SUPRA	Grandsire:	CH. MACEDON MARQUIS
	LARKSPUR		Blue Pt.
	Blue Pt.	Granddam:	SAMSARA CASCADE

Chocolate Pt.

KOUNTRY BOY

In the 1972-'73 show season he was in 22 CFA shows in which he was given 50 final wins including 24 Top Five awards of which several were Best Cat; and 78 Best of Breeds. He is the 1973 CFA National Colorpoint Shorthair; Northwest Regional 7th Best Cat, All Breed, and 5th Best Cat, Shorthair; and 3rd Best Shorthair Male. In ACFA he was named 1973 Regional and Inter-American Male of Color of Breed.

GR.CH. KASTLE ROCK KOUNTRY BOY, now over 2 years old, is retired from show. He is throwing kittens as good as and better than himself so we will let his sons and daughters take over for him.

ENGLAND'S TABBY POINTS (CONT'D FROM P. 19)

There have been many top winning Tabby-points over the past few years from numerous catteries. The greatest of these is *GRAND CHAMPION SEREMBAN LIGER*, England's very first Siamese Grand Champion. *LIGER*, bred by Mrs. Anne Aslin, is a superbly typical Seal Tabby-point with very deep blue eyes and a very pale coat. He won this award over tremendous competition; in fact, he competed against 30 leading Champions. This was a great achievement for his breeder and for Tabby-points in general. When so many people were putting up their objections to the new variety in the 60's, little did they think the first Grand Champion Siamese would be a Tabby-point.

At the Siamese Cat Club Show in 1972, most top honours were carried off by Tabby-points. *CH. ZILS ZENO* won the Grand Champion Certificate, and *PR. SUPRA TAI-PAN* the Grand Premier Certificate.

Tabby-points have won numerous Best-In-Show awards over the past season. A beautiful female, *MEIKLERIGGS HECATE*, was Best Kitten at the Wessex Champion Show, 1972, and an outstanding kitten, *SHYBU YOUNG SPYRO*, was Best Kitten at the Northern Siamese Champion Show, 1973. Another exquisite female, *CHEONA MEDEA*, was Best Female at the Siamese Cat Assn. Show 1973; she was bred by Mrs. Moore.

The tabby pattern is expressed as a result of a dominant gene. Therefore, cats bred from tabby points which do not show this pattern cannot produce tabby-pointed kittens unless bred to a tabby-point.

A problem which seems peculiar to most of the paler colour Tabby-points, i.e. Chocolate and Lilac, is lack of striping on the legs. I feel it is unfair for exhibits of this colouring to be penalized for this, as point colour develops last on the legs anyway and is usually less intense on this area in all Siamese.

Another problem is dark coats on Seal Tabby-points. Various breeders, including myself, are working on this problem.

One must own a Tabby-point to realize how intelligent, loving and cheeky they are! A cat of true beauty.

GR.CH. KASTL ROCK KOUNTRY BOY

<u>Sire:</u> YAMA'S SIGISMUND OF MIJIRI Seal Pt.	<u>Grandsire:</u> PASHT HARBINGEN OF YAMA Seal Pt.
	<u>Granddam:</u> MONDEE'S LIEBSCHEN OF YAMA Blue Pt.
<u>Dam:</u> SU LANI TU OF KASTLE ROCK Seal Lynx Pt.	<u>Grandsire:</u> KIMUELA Seal Lynx Pt.
	<u>Granddam:</u> SU LANI Seal Lynx Pt.

Dhyana Cattery

CFA Registered



BLUE POINT
SIAMESE KITTENS
BORN JULY 30, 1973

DHYANA'S LILLITH (KILDOWN, DAHIN LINES)
BY

CH. DULCE DOMUM'S KUBLAH OF DINAPOLI

Write or call for Pedigree Information:

MR. & MRS. E.B. SIMPSON
1224 CHESTNUT AVE., BEAUMONT, CA. 92223
1-714-845-1556

RUSSIAN BLUE ASSOCIATION

EXTENDS A CORDIAL INVITATION
TO BREEDERS & FANCIERS
IN ALL COUNTRIES OF THE WORLD
TO JOIN US.

LET'S EXCHANGE INFORMATION AND IDEAS FOR
THE BENEFIT & PROGRESS OF THIS VERY
SPECIAL BREED, PLEASE WRITE AND TELL US
ABOUT YOUR RUSSIAN BLUES & EXPERIENCES.

ALL LETTERS WELCOMED AND ANSWERED.

LINDA KIRSCH, Bulletin Editor
4161 DONALD DRIVE, PALO ALTO, CA. 94306 USA

★ Star Br't Persians

VOO DOO, SILVA WYTE, SHAWNEE
AND SIMBELAIR LINES.

CFA REG.
HEALTH GUARANTEED.

Blacks, Whites,
Bi-Colors & Solids
carrying AM. Bi Gene

BLACK KITTENS
HERE NOW FROM
DOUBLE VOO DOO CROSS

SHOW TYPE BLUE FEMALE,
5 MONTHS, & BLUE-CRM.
KITTEN FOR SALE.

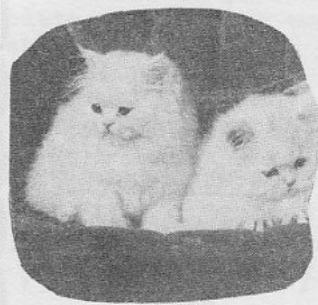

458 WEST AVE.
PITMAN, N.J. 08071
Phone: 609-589-2295

THE TABBY POINT SIAMESE (CONT'D FROM P.18)

Breed 32', and in January, 1967, the Shadow-point Siamese & Progressive Breeders Cat Club became the Tabbypoint Siamese & Progressive Breeders Cat Club and, with joint meetings and cooperation of the Tabbypoint Cat Society, have done and are doing much for these cats and all the new ones that inevitably result from any new breed such as the Blue Tabby-points, Chocolate Tabbypoints, Lilac Tabby-points and, recently, the Red and Tortie Tabbypoints.

GCCF TABBY POINT STANDARD (EFFECTIVE JUNE 20, 1973)

- TYPE & SHAPE:** As for Seal Pointed Siamese.
- GENERAL BODY COLOUR:** Pale coat, preferably free from body markings including back of head and neck and conforming to recognized Siamese standard for the particular colour of points.
- GENERAL POINTS COLOUR:** Same colour essential but varied tones acceptable, i.e. seal, blue, chocolate, lilac, red and cream. The standard for Tortie/Tabby Points is given below.
- EARS:** Solid, no stripes. Thumb marks as clear as possible.
- NOSE LEATHER:** Conforming to recognized Siamese standard for the particular colour of points or pink.
- MASK:** Clearly defined stripes, especially around the eyes and nose. Distinct markings on cheeks, darkly spotted whisker pads.
- EYES:** Brilliant clear blue. The lids to be dark rimmed or toning with the points.
- LEGS:** Clearly defined varied sized broken stripes. Solid markings on back of hind legs.
- TAIL:** Many varied sized clearly defined rings

Since the establishment of the Tabby-point Siamese we may look back and record our progress with satisfaction. These cats have superb type and eye colour, competing on equal terms for show honours with all other varieties of Siamese; the 'Miss Europe' last year was a beautiful Tabbypoint bred by Miss Brabyn, *INT. CH. SAKURA PARTHENIA*.

Having reached such a high standard, we must watch and concentrate on further improvements such as pale coats, strong chins, freedom from kinks, squints and other faults one finds in the Siamese breed as a whole.###

- ending in a solid tip.
- COAT:** Very short and fine in texture. Glossy and close lying.
- TORTIE/TABBY POINTS:** As above with the following exceptions. **Ears:** Mottled. **Nose and pad leathers:** Mottled. **Tail:** As above but mottling permissible. **Points:** Patched with red and/or cream over tabby pattern. Distribution of patching on points immaterial (as in standard for Tortie Points). **Note:** These cats usually resemble Tabby Points rather than Tortie Pts.

POINTS

Type and shape	50
Colour & condition	50
Ringed tail	10
Eyes	10
Body colour	15
Points and thumb marks	10
Texture of coat & general condn.	5

SCINTILLA

SIAMESE

SEAL AND BLUE POINTS OF CLASSIC ENGLISH PEDIGREE, ALSO A FEW QUALITY TABBY POINTS (LYNX COLOURPOINT SH)

FOREIGN WHITE

WHITE SHORTHAIRS SELECTIVELY BRED FOR DEEP BLUE EYES, SIAMESE TYPE AND WITH THE PREFIX THAT FOUNDED THE BREED.

ORIENTAL SMOKES, & ORIENTAL PASTELS

IN BLACK, SILVER, BLUE, COPPER, LAVENDER, APRICOT, IVORY AND ALL COLOURS DAPPLE.

ALSO OTHER SIAMESE TYPE SHORTHAIRS IN ALL COLOURS



Patricia Turner

Tel. Eastbourne 55891

7 BODIAM CRESCENT,
EASTBOURNE, BN 22 9HQ,
ENGLAND

THE
ABYSSINIAN
CAT

by
ROSEMONDE PELTZ

PUBLISHED BY
TEX-ABY CLUB

\$2.00 per copy

Thelma Wallner
5415 Candlecrest
Houston, Texas
77088

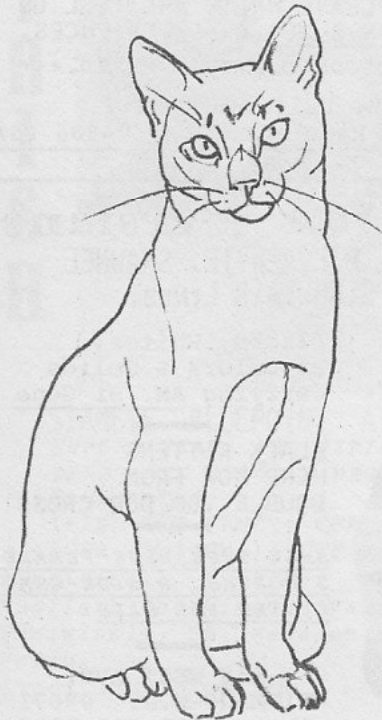

College Of Cat Genetics

Patricia Turner

STUDY UNIT 4

THE 1:2:1 RATIO

Some genes are not completely dominant over each other and this is true of the genes at the albino locus which are listed down the scale from full colour to siamese and possibly albino. In this series burmese is only partially dominant to siamese.

As the burmese/siamese heterozygote (Tonkanese) is reasonably well known, the experiment showing the ratio expected will be reconstructed with burmese and siamese.

The gene for burmese is symbolised c^b while the gene for siamese is symbolised c^s . As c^b is incompletely dominant over c^s the heterozygote is intermediate in effect.

A cross is made between a burmese and siamese, both homozygous.

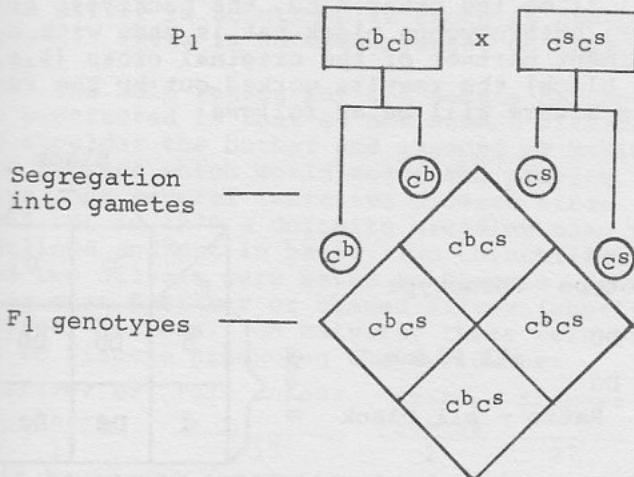

The mating between $c^b c^b \times c^s c^s$ giving the F1 genotypes of $c^b c^s$ and thus all kittens of intermediate effect.

In order to produce the F2 a mating is planned between the F1 littermates or between cats of genotype like them. Each of these

SOLUTIONS TO SEPT./OCT. "PROBLEMS":

1. 'What is meant by genotype

The genotype of the cat is its "recipe" or coded instructions for its voice, temperament, colour, conformation and all other characteristics. The phenotype of the cat is the total of characteristic that may be seen, smelt, heard or otherwise identified by the senses. Thus, a colour genotype is the complex of colour genes CARRIED on the chromosomes of a cat and the colour phenotype is the VISIBLE colour of the cat.

2. 'If a Blue cat is mated

If a Blue cat is mated to a homozygous Black cat, all the kittens will be Black.

3. 'What colour gene

The colour gene common to the Brown Burmese, Seal Point Siamese, Brown Tabby and Chinchilla is Black, i.e. the Black cat with two genes for Burmese dilution becomes the Brown Burmese; the Black cat with two genes for Siamese dilution becomes the Seal Point Siamese; the Black cat with one OR two genes for agouti becomes the Brown Tabby and the Black cat with one or two genes for melanin inhibitor AND one or two genes for agouti becomes the Chinchilla.

cats produces two types of gametes and again four types of fertilisation are possible.

Genotype Phenotype

1 $c^b c^b$ = Burmese

2 $c^b c^s$ = Tonkanese

1 $c^s c^s$ = Siamese

RATIO 1:2:1

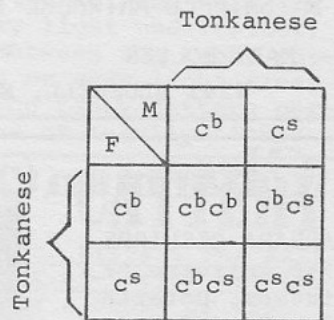

It should be remembered that the ratios relate only to the two alleles under investigation and that type and other factors are not included. Since 'type' is due to the joint action of many genes the F1 and F2 kittens in the above examples would be of indeterminate type.

Advertising Deadline
For Next Issue: Dec. 7

RAMSU REX

FINE
CORNISH REX

MALCOLM & BETTY LAUDER
31 BEVERLEY CLOSE, RAINHAM, GILLINGHAM,
KENT ME8 9HG, ENGLAND

LOVELY Siamese Cattery

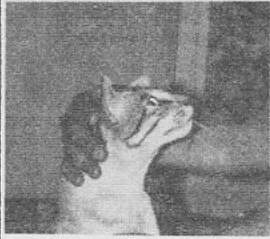

OFFERS AT STUD:
 ALL-EASTERN SEAL LYNXPT. '73
 ← "FUZZLE"
 ALL-EASTERN BLUE LYNXPT. '73
 "BRUJO"

AND CH. MALES IN RED; CHOC.; LILAC;
 ALBINO; WHITE.
 ALSO AT STUD: QUINT. CH. ABYSSINIAN

KITTENS IN ALL COLORS; BOTH BREEDS

RD #2, BOX 758, ANNVILLE, PA. 17003
 Phone: (717) 867-4275

SI-ABY Cattery

KITTENS FOR CHRISTMAS

PET-TYPE ABYSSINIANS
 AT A PRICE YOU CAN AFFORD.

JUST IN TIME FOR CHRISTMAS.



★ SHIPPED ANYWHERE IN U.S. & CANADA ★

MARY BOLLES Ph.: 901-785-2381
 4541 BLUEBELL, MEMPHIS, TENN.

Charmant Persians

BARBARA DESLIPPE
 1790 Golfview Dr.
 Windsor, Ontario
 N9J 1Y9 - CANADA

KITTENS
 STUD SERVICE
 ADULTS OCCAS.

MOST COLOURS,
 SPEC. IN
 BLACKS & SMOKES

Regd.: CFA, CCA,
 ACFA, NCFA, CFF. CH. CHARMANTE'S BLACK MAGIC

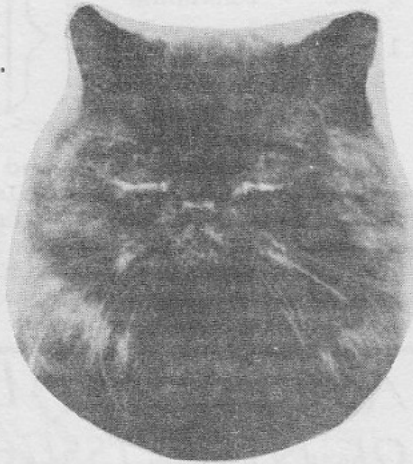

THE BACKCROSS

If a cat that is heterozygous for any one characteristic is mated to either of the two parental types the mating is called a backcross. As has been described the heterozygote forms two types of gametes while the homozygote forms only one. So fertilization results in a genotype ratio of 1:1.

The factors of dominance, partial dominance and recessivity then dictate the phenotypic ratio.

If an F₁ cat of the mating between the original blue and black cats is then backcrossed to its blue parent or to another blue the results will be as follows:

		Blue		
		M	d	d
Genotype	F	d	dd	dd
	2dd	2 Blue		
	2Dd	2 Black		
	Black	D	Dd	Dd
		Ratio 1:1		

If on the other hand, the backcross of an F₁ heterozygous black cat is made with a dominant partner of the original cross (i.e. the black) the results worked out by the Punnett Square will be as follows:

		Black		
		M	D	D
Genotype	F	D	DD	DD
	2 DD	all Black		
	2 Dd	Ratio - all black		
	Black	d	Dd	Dd

SPECIAL REPORT

GENETICS OF SILVER & SMOKE

BY PATRICIA TURNER & ROY ROBINSON

The precise heredity of silver, chinchilla and smoke has been the subject of debate in the fancy for a number of years especially between the more discerning cat breeders, who felt that their experience contradicted the current explanation of recessive inheritance of silver and smoke, and geneticists, who based their opinion on the published evidence. This article presents breeding results which show that the old explanation will have to be revised.

But, firstly, a little history. In 1933 Clyde S. Keeler and Virginia Cobb published the results of crosses between smoke and

NOTE: Students wishing further clarification on material presented in this series are invited to write to Miss Turner, C.G.I.C., 7 Bodiam Crescent, Eastbourne BN22 9HQ, England. Although personal replies will not be sent, questions she receives will provide the basis for the next "Students' Seminar" to be published in an upcoming issue of CAT WORLD.

black longhairs and silver, smoke longhairs and Siamese (i.e. smoke x black LH, smoke x Siamese, etc.) which indicated that the gene for silver was inherited as a recessive to full colour but dominant to Siamese. Since Siamese is known to be inherited as a recessive to full colour (i.e. black, blue, etc.), these results implied that full colour (represented in the crosses as tabby or black), silver or smoke and Siamese were a series of three alternative genes. In support of this conclusion, silver and Siamese were likened to Chinchilla and Himalayan of the rabbit which are known to be inherited in this manner. Anyone who is familiar with these varieties of rabbit cannot fail to be impressed by the similarity of appearance of silver and chinchilla and Siamese and Himalayan. The difference between silver and smoke cats is that silver is agouti while smoke is non-agouti. There is no disagreement on this point.

The main reason why the debate has been so protracted is that no one seemed willing to shoulder the bother and expense of making the crosses which would solve the problem. We have made several tentative crosses since 1968 but in 1970 a definite breeding plan was outlined and put in hand. Two Chinchillas and two Silvers were mated to Siamese, producing over 8 silver or shaded-silver (short-haired) kittens. On maturity these were mated to Siamese producing the following:

Silver or Smoke	Full colour	Smoke Siamese	Siamese
17	13	2	27

This backcross generation is decisive and deserves to be examined in detail. On the Keeler-Cobb explanation, the 15 kittens of the two centre classes should not have occurred. In more detail these are 2 black, 1 blue, 1 lilac, 1 blue-cream, 2 blue tabby, 6 brown tabby and 2 Siamese Smoke. Now it could be argued that the first 7 kittens are in reality smoke in which the white undercolour has either failed to appear or is indistinct. This is true and is recognised. However, the 6 brown tabbies were unmistakable. The two smoke Siamese were also unmistakable in that they were Seal except for the white undercolour of the smoke and distinctive tabby facial markings. Only two of these have been definitely observed but others may well have been bred. It is well known that young Smoke kittens are not always easy to classify. The majority of the Siamese in the last group are agouti and we have found it impossible to

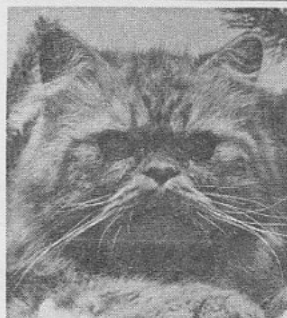

Kamolot Call Me
Mr. Smyth

KAMOLOT Cattery

CAMEO KITTENS
(Born Sept., 1973)
FROM CH. & INT. CH.
SHADED CAMEO FEMALE
X TRIPLE CROSS RED
MALE FROM GR. CH.
STONYBROOK LANE.

SOLIDS * SMOKES * CAMEOS * PARTICOLORS
CCA ACFA CFA

STONYBROOK, ERMAN, BLOEMHILL, LOWLANDS
& AZULITA BLOODLINES.

ART & PAT KLIMACK Ph. 716-392-7451
211 Peck Road, Hilton, N.Y. 14468 USA

distinguish the young kitten that is the Siamese equivalent of the "Shaded Silver" from an ordinary agouti Siamese (Tabby Point).

We have concluded that the above breeding results are consistent with the heredity of a dominant gene which is independent of Siamese. Those breeders who have been maintaining that silver and smoke are inherited as a dominant are thus vindicated. However, it has not been possible hitherto to show that the gene is independent of Siamese and this has now been accomplished. We have symbolised the gene by I (denoting inhibition of hair melanin). The action of the gene is to partially inhibit the formation of melanin in the coat - the effect being most pronounced for those areas which are least pigmented. That is, the basal portion of the hair (to produce a white or very light undercolour) and the agouti areas between the tabby pattern (to produce white or very light areas with dark ticking). The tabby pattern persists as concentrations of heavily ticked

FIDDLER'S CATTERY

LOVELY FROST & BLUE PT. KITTENS FOR SALE
NOW ... INCLUDING PICK-OF-LITTER KITTEN.
THESE KITTENS ARE FROM A CROSS OF THE
FINE YAMA/SUNDUST LINES: QD.CH. TULARENSIA
SYNDI x SUNDUST BO JANGLES.

SEAL POINT AT STUD:

FIDDLER'S PHANTOM
OF THE OPERA

Senior Ch.; sire of
judge M. Potter's
BEST KITTEN at 1973
Prairie State show.

MRS. G. HIGGINS
2112 Delcy,
Rockford, Il. 61107
Ph.: 815-398-6247



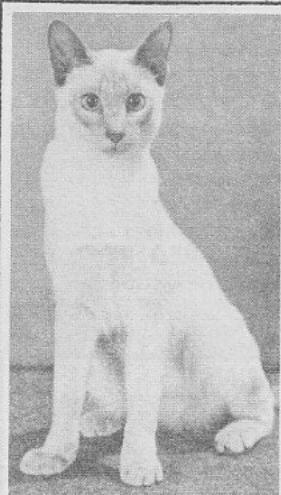

Cattery van POELGEEST

PERSIANS & SIAMESE

INTL. CHAMPION SHOW CATS
BEST EUROPEAN BLOODLINES

Oct. 20-21: A BIG Weekend!

AMSTERDAM, HOLLAND:

CATTELEYA'S MERRY-GO-ROUND
VAN POELGEEST (LPf) - CAC
& Best Siamese Opp. Sex;

CATTELEYA'S SOCRATES VAN
POELGEEST (CPn) - CAPIB &
Best Neuter in Show;

LYONS, FRANCE:

CATTELEYA'S HAPPY-GO-LUCKY
VAN POELGEEST (Lpm)-CACIB.
(All 3, Best in Colour Var)

MERRY-GO-ROUND

MEVR. J. J. MOORMAN — Wltte de Withlaan 1 — Oegstgeest
HOLLAND
Tel. 01710 - 52402

hairs over a white undercolour. This is the silver and it is easy to perceive why it should be confused with a chinchillated animal.

A chinchillated animal is one in which all (or most) yellow pigment is removed. It so happens that the agouti areas most strongly affected by the action of the I gene are those which manifest most of the yellow pigment in the coat. The mongrel silver often shows a suffusion of yellow on the head and back but this has been eliminated from the exhibition silver by selective breeding. Small wonder that the silver resembles a chinchillated animal but the resemblance is misleading genetically.

In the smoke, the white undercolour persists but the action of the non-agouti gene is to extend the black ticking to all parts of the coat. The points become very dark or black and the amount of white undercolour is reduced. There is considerable variation of undercolour as a matter of fact. In some animals the undercolour is obvious, with only the tips of the hairs being pigmented. In others, the undercolour is merely lighter than usual and the cat may, superficially, be mistaken for an ordinary black. Indeed, there are indications that some smokes so closely resemble blacks that even experienced observers are confused. The occurrence of smokes that are apparently black explains the misleading fact that two "blacks" may produce smoke kittens if either parent has a smoke sire or dam.

2-Year CAT WORLD BINDERS - \$4.50 EACH

ATTRACTIVE BINDER SPECIALLY DESIGNED TO HOLD 12 ISSUES OF "CAT WORLD". LIMITED SUPPLY AVAILABLE. SEND ORDERS TO: 5395 S.MILLER, LITTLETON, CO. 80123.

The chinchilla cat is an interesting breed, particularly in relation to the silver. That the two are related is obvious. In fact, for a short while in kittenhood, the chinchilla looks like a silver but quickly loses the tabby pattern, becoming almost white except for fine black tipping. It has long been accepted that the chinchilla differs genetically from silver by the possession of modifying genes increasing the white undercolour. There is no reason to change this supposition except perhaps to make it more precise. The chinchilla is the extreme expression of the I gene, where the pigmentation has been confined to the tip of the hair. The long hair probably enhances the effect although shorthaired chinchillas are known. The amount and/or quality of the tipping is variable as shown by the occurrence of the shaded silver (in the U.S.A. particularly). It is possible that the I gene is semi-dominant so that II is chinchilla and Ii is shaded silver. We hope to investigate this interesting possibility in due course.

Is it possible to reconcile the breeding data reported by Keeler and Cobb with the present hypothesis? There is only one cross reported by these authors which would seem in direct disagreement and that is the mating of two black cats which produced 5 black and 1 smoke kitten. However, this is not decisive since smoke can resemble black and one parent may have been smoke. In the initial crosses, a smoke mated to a black gave 5 black and mated to a tabby gave 4 tabby. Usually the sum of these two litters (9 kittens) would be sufficient to establish statistically (but not genetically) that smoke is inherited as a recessive but, strictly speaking, the black kittens cannot be counted (because one or more could be dark smoke) and the 4 tabbies by themselves are not numerically sufficient. It is perhaps pertinent to note that Keeler and Cobb remark that one of the smoke kittens produced during their experiments was "darker than the rest and gave evidence of the silver factor only upon the appendages and about the eyes".

There remains the possibility that Keeler and Cobb did actually discover a silver gene which is recessive to black. This idea implies that two genes for silver exist in the cat. Well, it is possible but improbable in our view. Only the future can decide this question. Keeler and Cobb experimented with cats of North America while ours are British stock with remote ancestry featuring imported chinchilla cats. But this difference is immaterial for several American breeders have been just as adamant as the British that silver or smoke are inherited as a dominant. The same opinion has been expressed by a breeder in South Africa.

We would like to acknowledge the practical help given in this breeding project by Mrs. A. Law, Upton, Yorkshire, and Mrs. S. Scott, Withyham, Sussex.###

LETTERS

ANOTHER LITTER OF ELEVEN

(See Mrs. Dew's letter, p.18, Sept./Oct. CW)
I am enclosing a rather yellowed newspaper clipping with a picture of 11 Siamese kittens in one litter. I'm sorry that I cannot provide the name of the newspaper or the date of publication. The picture has been in our files for a year or two, and it was sent to us without any other information. We have, in the past, heard of Siamese litters of 12.

Mrs. Jean B. Rose, Executive Director,
Cat Fanciers Assn., P.O. Box
430, Red Bank, N.J. 07701, U.S.A.

(Editors' Note: We are unable to reproduce the photo; however, the caption indicates the litter was born to "Cissy", 2-year-old Siamese owned by Mrs. J. Poustechnik, Josefa's Poodle Salon, 45 N. Common Rd., Westminister, Mass. U.S.A.)

INTERESTED IN MANX

CAT WORLD arrived this morning and no work has been done since. As I breed Manx, I was so pleased to see the cover (July/August). They are not too numerous and it was a delight to see such a magnificent cat.

Is there a Manx Cat Club in America with whom I could get in touch? I hope to be able to get a wider knowledge of this so friendly breed and would like to compare notes with others of the same interest.

Mrs. Iris M. Burgess, 2 Queens Sq.
Eastwood, Notts. NG16 1BJ, England

BURMESE LIBRARY

My husband and I have been doing a lot of research trying to set up a Burmese Library and Stud File. So far we have about 3,000 Burmese cats listed with registrations, sire and dam; and have photo copies of the Burmese pages from ACA, CFA, CFF and GCCF from the complete set.

Our Stud File works on an open plan. Any Burmese breeder sending us records to help expand ours will always be able to call or write us and we will help fill in the holes in pedigree that may be missing for them. This is free to all who help us. All pedigrees are photocopied by us and sent back by registered mail, the way we ask breeders to send their records to us.

Mrs. Frank Smith, 5405 Entrada Cedros,
San Jose, Calif. 95123 U.S.A.

CANADIAN CAT CLUB STUDYING GENETICS

We find CAT WORLD articles most inspiring and at our September meeting one of our members who is well-versed in the subject of genetics begins student classes using the Study Units as outlined in your issues. I am looking forward to these discussions because genetics has been way over my head for years! I am not alone in this "lost" feeling and it will be a relief to know what we're talking about. This was prompted mostly by your easy-to-interpret articles!

Mrs. Carol Matthew, Secretary,
York Cheshire Cat Club, 194 Alfred
Ave., Willowdale, Ontario, Canada

SIAMESE AND FOREIGN IN ASSORTED COLOURS



QUEENS: SHANTAI SUN FLOWER (Red Point)
PALANTIR CELEBRIAN (Choc. Tortie Pt.)
PHAEON PHANDANGO (Chocolate Pt.)

NINE KITTENS FROM SUN FLOWER
By CH. ASUNI AOI HOSI (BP)
READY END OF NOVEMBER
(RPs., Cream Pt., Seal & Blue Tortie Pts.)

JULIA M. MAY
265, GREEN LANES, LONDON N.13, ENGLAND

HERITAGE (CONT'D FROM P.4)

In 1960 BROUGHTON JANE went to Joan Richards to help establish the Pensylva line. The following year, bred to JEZREEL JAKE, BROUGHTON JANE delivered a lovely blue named PENSYLVA BELLA. In 1962 the same cross produced PENSYLVA QUICKEE. And in that same year Mrs. I. Johnson's JEZREEL JOMO was born. Sired by ALDRA'S DARK TALISMAN, JOMO is perhaps one of the finest British Shorthairs ever bred.

BROUGHTON JANE will be remembered for years to come as one of the most significant cats in the history of the British Shorthairs. She lived to January, 1971. Mrs. Richards has told me the poignant story of JANE's last day. She had cancer and, on the morning of her death, one of her daughters presented a litter of JANE's grandchildren. Mrs. Richards says, "she showed interest and gave each a brief lick, and her contentment and life seemed complete." Thus BROUGHTON JANE died at the age of sixteen years, leaving to us a distinguished line of lovely cats.

The Pensylva and Jexreel Blue-Creams were particularly outstanding, and these two catteries produced some extraordinary cream shorthairs. The line of succession passed from Mingswyck and Jezreel to Aldra to Pensylva. Perhaps the best known of the creams are ALDRA'S CREAM BUNNE, BAMBI'S MISCHIEF (a neuter bred by Mrs. Hughes and owned by Mrs. Richards) and the Pensylva cats: GAIETY GIRL, FLAXEN NYMPH, PINK CHAMPAGNE, BLOND BANDIT, PINKERTON and PRINCE D'OR.

Each year brings new breeders into the devoted group of British Shorthair Fanciers. Most recently the Absalom cats have been honored. Other colors and patterns are very popular, but it was the British Blue, Blue-Cream and Cream that drew attention to the breed and won friends throughout the world##

RAMESES (CONTD. FROM P.17)

We showed her to 5th Best CFA Foreign Shorthair and she took top Regional Cat and Best Shorthair right up to the last year of her show career. We retired her at the age of 5. She has given us several litters of lovely kittens and is very special to us. She has produced several Grand Champions including GRAND CH. PHAROH CITATION OF SWINGATE and GRAND CH. PHAROH GINGER OF BOBBI-JEAN, both sired by MAN O' WAR, all grandchildren of PHAROH RAMESES II.

RED's sire, KIZAN, we sold several years ago as we could not keep more than one male uncaged and he, I am pleased to say, is now

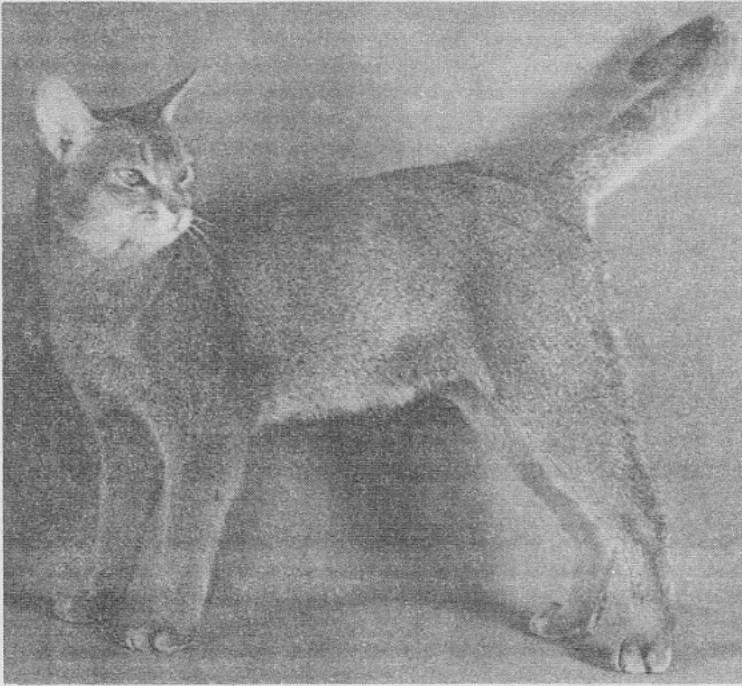
VETERINARY VIEWS (CONTD. FROM P.13)

only will they be delayed, if not rejected, at vetting-in, but no judge is likely to give them a high award.

The second part of the preparation concerns the cat's upbringing. Many cats resent having their mouths opened or their ears examined because they associate these procedures with pills or lotions and they are, therefore, easily upset and difficult to examine. If the owner will look in a kitten's ears and mouth as part of the grooming routine right from the start, it will accept it without complaint (and you will spot signs of trouble sooner). It is also useful to accustom the cat to being restrained by the scruff of the neck in case this is ever necessary at a show.

I hear that in the United States exhibitors are asked to trim their cats' claws before arrival at a show: this reduces the risk of damage to judges and stewards if the cat is frightened or loses its temper. I know that many experienced exhibitors here in Britain already prepare their cats in this

sixteen years old. He lives in a lovely home in Wisconsin and still produces lovely kittens. TANJII, RED's dam, died the past summer at 14 years of age quietly in her sleep.

GR.CH. PHAROH CITATION OF SWINGATE

Both JUNIOR and RED's several sons and daughters and grandchildren have done him credit. Most of the leading Abyssinians in America today have RED behind them. PHAROH CITATION OF SWINGATE, 1973 CFA BEST CAT, is RED's grandson five times over on both sides.

CI has broken his Grandad's record of 44 Best Cat awards won in one season by an Aby and his 90 Best Cat awards not only set a World record for any breed of cat but also gave him one more than the 89 Best Cat wins BIG RED achieved in his three-year show career as an adult. At the end of the past show season, April 30, 1973, this fine Aby was still only 19 months old and had competed in 33 shows.

Those who remember RED feel that CI looks so much like him. He possesses that same 'pzazz' in the show ring and has that great quality about him. We have retired him from the show circuit at the youngest age of any of our cats. Abyssinians are like good wine, they improve with age, but he has proved his worth by going BEST CAT in all eight Regions of the country and is more important to us as a sire of top kittens and, above all, as "our boy".

CI and JUNIOR can always be seen in their home which we are lucky enough to share with them.###

1973 BEST CAT, CAT FANCIERS ASSN., U.S.A. - GR.CH. PHAROH CITATION OF SWINGATE, grandson of GR.CH. PHAROH RAMESES II. This Aby male set a new record by winning a total of 90 BEST CAT awards in one show season.

way, but I feel it would be an excellent idea if more people considered it.

FEEDING ORPHANED KITTENS

I was interested to note Dr. Sealing's article in the last issue of CAT WORLD on rearing orphaned kittens.

To feed such kittens, I feel it would be advisable to first try them with a specially designed feeding bottle (see back cover, CAT WORLD, May/June, 1973) and proprietary feed. A strong kitten will usually suck well when the teat is placed in its mouth.

The amount of feed delivered is controlled by the size of hole in the teat, and the amount of air allowed in at the other end of the bottle. Provided that the kitten is not allowed to suck more feed in than it can swallow, it will not suffocate.

Dr. Sealing's instructions on the preparation of the feed and the necessity for frequent feeds apply equally to bottle feeding. Only if the kitten refuses to accept the bottle, or will not take adequate amounts at each feed, would I advise tube-feeding.###

PERUSE & CHOOSE

TO PLACE YOUR ADVERTISEMENT:

Type or print your advertisement on a plain sheet of paper, indicate title under which it is to appear, and mail (with payment in full) to: CAT WORLD, 5395 South Miller St., Littleton, Colorado 80123, U.S.A.

Residents of U.S.A. and countries other than the United Kingdom are requested to pay in U.S. funds. Check or money order should be made payable to CAT WORLD.

UNITED KINGDOM residents may pay in British sterling by cheque or postal order made payable to S.R. Thompson. It is not necessary to obtain U.S. funds.

RATES	Total Cost	
	For 3 Issues	For 6 Issues
Up to 25 words	US \$5.00 UK £2.00	US \$8.00 UK £3.20
Each extra word	US .20¢ UK 8p	US .32¢ UK 13p

Cat Clubs

TEESSIDE CAT CLUB WELCOMES ALL CAT-LOVERS. REGULAR Meetings and Newsletters. Secretary, 19, Roseberry Drive, Great Ayton, Teesside, TS9 6EQ, ENGLAND a

THE ORIGINAL TURKISH ANGORA SOCIETY INVITES INQUIRIES. Mrs. George Thornton, 2750 S. Jamie Avenue, Tucson, Arizona 85706 USA. Phone: (602) 883-3413 a

Cats At Stud

COLORPOINT SH. CFA CH. BODANTE UTOPIAN, RED PT. PROVEN. Best NW Red Point, 1973. Straight import lines. 5395 So. Miller St., Littleton, Co. 80123 USA. 303-986-0442. b

HIMALAYAN. BADI SOLO DOMINIC, SP SON OF MINGCHIU MURDOCK of Badi, grandson of Chestermere Chu-Woo. Stud fee: \$125.00. Badi Cattery, 105 Young Blvd., Universal City Texas 78148 USA. Ph. 512-658-4912. a

SIAMESE. RM TR.GR.CH. FLUME WIRE OF ANGLO-TEX, IMP. "Shad" still winning as this year's ACFA Regional Honorable Mention male of color of breed. Elegant-long-type! Beth Smith, 2565 So. High St., Denver, Colo. 80210 USA. Tel: 778-1401 a

SIAMESE. HI-STYLES SIAMESE. STARFIRE, SON OF GRAND Champion Makhanda Marauder. Bloodlines: Makhanda, Sanuk's, Wolfgang, Maloja, Sia-Mews. Nancy Stiles, 15309 Lassen, Mission Hills, Calif. 91340 USA e

CORNISH REX - BLACK SMOKE CFA AND ACFA GRAND CHAMPION Nike Glimmer of Chalonai. Exquisite type, very marcel waved. (See "Gallery" for picture). Linda Wilson, Route 4, Box 128, Liberty, Mo. 64068. USA. 816-781-6808. f

Multiple

CONCHO CATTERY OFFERS SABLE BURMESE WITH EVEN, BARLESS coats and typey Siamese, primarily Blue Points. Top bloodlines, unequaled personality, health guaranteed. Ruth Phillips, 1305 E. Mulberry, Apt. 8, San Antonio, Texas 78209 USA Ph. 512/824-7054 a

COPPLESTONE PERSIANS/HIMALAYANS/BURMESE. HIGH QUALITY show/breeding stock usually for sale. Reasonable prices Also kittens as above. Mrs. W. Bentinck, Sparks Farm, Barkham, Wokingham, Berkshire RG11 4TL ENGLAND a

JASSY'S AND INX CATTERIES--ACA, ACFA, CFA HOME-RAISED Persians and Manx. Any color Persian; Black, Blue, Tabby, Calico Manx. 480 Temple St., Satellite Beach, Fl. 32937 USA. Ph: 305-262-3133 b

HAPPY DAYS, KITTENS: BLUE ABYSSINIANS, PETS, LAVENDER male--HB parents, Rex, Russian Blues, and Persians from imports. 18 Pleasant View, Milford, Ohio 45150 USA. 513-831-5475. b

LIMMERICK CATTERY: COLOR-BRED CHOCOLATE AND BLUE POINT Siamese; Korats from proven Thai origin; kittens, stud service. The Broadbents, 2801 Nantucket Court, Winston-Salem, North Carolina 27103 USA. 919-768-7173 f

PEARCROFT PERSIANS, BLUE, BROWN TABBY. SIAMESE, LILAC, Bluepoint. British Blues. Kittens from well-known, successful lines. Mrs. Diana Jarrett, Pearcroft, Aston Fields, Ashchurch, Gloucestershire, England. f

AN-TAI-LIS: BALINESE, LYNXPONTS, SIAMESE. EXCELLENT bloodlines. Healthy purr-petual purrers. Stud service. Free Fauve sample (vitamin-mineral supplement). A.T. Longo, 15609 Colebright, Strongsville, Ohio 44136 USA (216) 238-5444. c

HEPHZIBAH CATS. CORNISH REX AND BIRMAN. SEE ADVERTISEMENT under those headings. Beautiful healthy cats reared in idyllic peaceful country surroundings with great love and care. Mrs. Margaret John, England. c

HAPPY DAYS REDUCING BECAUSE OF ILLNESS: ABYSSINIANS, Burmese, Havana Browns, Rex, Russian Blues; cats and kittens. Some imports. 18 Pleasant View Drive, Milford, Ohio 45150 USA. 513-831-5475. f

ARBAYBI BIRMANS AND BURMESE. HOUSE-REARED KITTENS WITH purr-fect temperaments. Enquiries welcomed. Mrs. Jean Park, 13 Eastmere Road, Wigston Magna, Leicester, England. Telephone: Leicester 884889. c

BRYLOU: HAVE CHINCHILLA AND DEVON REX KITTENS FOR SALE to loving homes only. Enquiries welcome. Mrs. Louvane Stevenson, 9 Park Crescent, Retford, Nottinghamshire, England. Retford 2128. c

COHANA LYNXPONTS/RED ABYSSINIAN/ASH CLASSIC SILVER, queens/stud service/kittens usually available. Graham, R.R.#3, Box 9, Paris Pike, Lexington, Ky. 40505 USA. 606-299-8394 c

HARVARD CATTERY - "THE BEST" IN PERSIANS OR MANX. Kittens for sale from top show cat parents, show/breeding. All colours. Reasonable. Eileen Power, 4371 Harvard Avenue, Montreal 260, Quebec, Canada. Ph: 514-488-6787 c

DOBHRAN CATS. SIAMESE, BURMESE, ABYSSINIANS. TOP quality kittens from prize-winning stock usually available. Burmese at stud. Excellent type, temperament. Patricia Lamb, 41 Blendon Drive, Bexley, England. 01-304-1288 f

CATTERY OF HOGGAR. HIS COLOURS--BLUE AND SEAL POINTS; his Persians--all colours. Issued of British parents. Vaccinated; with pedigrees. POB. 160, Geneva 6, SWITZERLAND. e

CYMRI CATTERY--GEOFFREY CATS (SMALL S.A. SPOTTED WILD-cats). Home raised and housebroken. Also registered CFA Persians and Siamese. Pedulla, P.O. Box 429, Drexel Hills, Pa. 19026 USA. Phone 215-H19-7615. e

EGYPTIAN MAU/BURMESE, TOP BLOODLINES, HOME-RAISED. SHOW/Breeding/Pet kittens. Khufu Cattery/Don and Barbara Karlson, 41 Washington Ave., South Amboy, N.J. 08879 USA e

LONGHAIRS - LUXURIOUS PERSIANS AND AUTHENTIC TURKISH Angora. Show and breed quality. Silver varieties, Cream Blue and Blue Cream. Copper and Blue-Eyed Angoras. Also unique new Solid Chocolate Brown. Stud service. Debra Earle, Earros Cattery, P.O. Box 8, East Hardwick, Vt. 05836 USA e

SUPERB KITTENS, QUEENS, STUDS. RUDDY/RED ABYSSINIAN; Siamese in four colors; Persians, Cream. Healthy, sweet-tempered, inoculated. Top lines. Martha Hamilton, 951 Mathews Avenue, Charleston, W.Va. 25302 USA. 304-342-3589 c

Abyssinian

COMPANION CATS. ACCA MEMBER, PET PRIDE APPROVED. TOP-quality Reds--home-raised. \$100 to \$300. Send 50¢ and two 8¢ stamps for "Information Packet." Ms. Pam Black, Route 1, Dover, Ohio 44622 USA.

ABYSSINIAN (Cont'd)

SIGIRIYA ABYSSINIANS--RED AND RUDDY KITTENS FROM CHAMPIONS for sale. Best Litter In Show, May, 1973. Mr. Joergen Andersen, Eckersbergsveu 31, OK-5000 Odense, Denmark. f

American SH

ALL-AMERICAN BLACK SMOKE AT STUD. CARRIES EXCELLENT EYE color. Blue-cream, Blue kittens in September sired by first CFA Cream Tabby Grand. Satin Song Cattery, 915 Valley View Drive, S. Charleston, W.Va. 25309 USA b

SHERETA. CFA BLUE/BLUECREAM. EXCELLENT DISPOSITION. Inquiries answered promptly. Greta Spencer, 132 Oakwood Rd., Charleston, W.V. 25314 USA. Phone: 304-342-6424 a

RM QD GR CH JOELWYN COLUMBYAN, ALL-AMERICAN CAT OF THE Year now at stud. \$200. Joann Sneed, P.O. Box 8271, Riverside, Calif. 92505 USA. a

Birman

SMOKEYHILL BIRMANS AND HIMALAYANS. TOP SHOW KITTENS occasionally available from my Champion queens and studs. Miss Brown, Castle Lea, Crete Road West, Folkestone, Kent, ENGLAND. a

HEPHZIBAH BIRMAN. STRONG, LOVING KITTENS FROM FRENCH & German bloodlines occasionally available from our four queens and three studs. Seal or blue. Mrs. Margaret John, Hollyhurst, Chiddingfold, Surrey, England. d

MASK RIDER BIRMANS--LOVELY KITTENS & YOUNG ADULTS FROM choice bloodlines. Imported & American stock. Fay Mosier, 16601 S.W. 236th St., Homestead, Fl. 33030 USA. Ph. 305-247-8488. a

PRAHA BIRMANS, HOUSE OF CHAMPIONS. "THEY SEEK THEM HERE, They seek them there, They seek them everywhere, These elusive, beautiful Praha Birmans." Kittens sometimes available. 47 Marlborough Mansions, Cannon Hill, London NW6 1JS England. b

British Shorthairs

DENMARK'S ONLY BREEDER OF RED TABBY SHORTHAIRES! MALE: Asser, and female: Aino von Casselgreen, 19. Have also beautiful female: Boomerang Blue Belle, 16. Lene W. Casselgreen, Platanale 17, DK - 8700 Horsens, Denmark d

Burmese

ARAKAN--BEAUTIFUL, CHUNKY, BOUNCY, BARLESS, BROWN, BABY Burms. Kittens, stud service. Joanne - Gary Lucas, 5925 Brookside, Kansas City, Mo. 64113 USA. Phone: (816) 363-4857. c

BURMESE--REASONABLE PRICES. SABLES ONLY. CHAMPION MALES at stud. Kittens occasionally. Pet/show quality. Inquiries invited, Deals, 5 Lazee Trail, Houston, Tx. 77024 USA. 713-461-2436. c

ILUSKASS BURMESE. THE CATTERY IN AN OLD ENGLISH GARDEN usually has kittens available, all colours including glamorous Cream and Reds. Bred from Champion stock. Hygienically and lovingly reared. Coloured photographs and pedigrees willingly forwarded. Apply Mrs. B. Procter "Iluskass" Hurst Lane, Egham, Surrey, England. c

BURMA MATAGOT SABLE BURMESE KITTENS. MANY CFA GRAND Champions in background. Born May 4th. Available for new show season. Nadine Buell, 1601 Redwood St. Vallejo, Calif. 94590 USA. Phone: 707-642-3756. f

TOPAZ CATTERY: SABLE BURMESE SHOW KITTENS AVAILABLE from Gr. Champions. Stud service. Experienced shippers domestic and intercontinental. Louis & Barbara Hart, 117 W. S. College St., Yellow Springs, Ohio 45387 USA. Ph. 513-767-7769. f

CALIFORNIA--SABLE BURMESE. QUALITY BREED STOCK. KITTENS available. Pet or show. Stud service. Lester; 617 Taraval St., San Francisco, Ca. 94116. Ph. 415-661-2000. d

AH-SEE CATTERY. SABLE BURMESE FINEST BLOODLINES. KITTENS proven adults and stud service available. Inquiries promptly answered. 503 S. Carroll, Michigan City, Ind. 46360 USA. 219-872-8030 a

TRAIMENE BURMESE: BLUE, SABLE KITTENS FROM CHAMPIONS Will reserve show/breeder/pet. Guaranteed health, temperament. Sable stud service. Bagshaw, 85 Rockport St., Marshfield, Mass. 02050 USA. Ph. 617-837-0218 b

ANDEER CATTERY. CHAMPAGNE BURMESE. FINEST BLOODLINES, very typie. Stud service, kittens available. Pet/show. Don & Sharon Grischott, P.O. Box 145, Westley, Calif. 95387 USA. Ph: 209-894-3251. e

Colorpoint SH

LYNXPOINT KITTENS FROM CHAMPIONSHIP LINES & 18-MONTH Lynxpoint male for sale. House of Yen Cattery, 342 Academy St., So. Orange, N.J. 07079 USA. Tel. (201) 762-1443. a

CFA-REGD. RED-, TORTIE-, LYNX-POINTS. KITTENS & ADULTS. Top British/American lines. Show/breeding/pet quality. Stud service. Cornish Rex kittens from Grand Champions. Bodante Cattery, 5395 S. Miller St., Littleton, Colo. 80123. Ph.: 303-986-0442. b

SHOW QUALITY RED, TORTI, & LILAC PT. SIAMESE. GR.CH. Don Jose, CFA NW Region Best Red Color Pt. 71-72, at stud. Kittens ready now. Pictures and pedigree on request. HU-MAN Cats, 1926 W. 6255 S., Salt Lake City, Ut 84118 USA. Ph. 801/298-5280 a

Exotic Shorthairs

BLUE AND BLUE-CREAM KITTENS, BLUE MOTHER, CREAM EXOTIC father. Outstanding copper eye color. Write for prices and pedigrees. Navajo Cattery, Martha Myrick and Jo Meyer, 333 E. Greenway Rd., Phoenix, Ariz. 85040 USA. a

Havana Brown

TOBACCO RD. OUTSTANDING HAVANAS WITH CHOCOLATE COATS. Top bloodlines. Cats, kittens. Limited stud service. Edward Windham, 4422 Temecula St., San Diego, Ca. 92107 USA. 714-225-1532. b

Himalayan

PITTMAN'S HIMALAYANS, KITTENS AND CATS, SEAL POINT, Blue Point, Lilac Point, Choc. Points, Bluecream Points Flame Points, Tortie Points and hybrids. Stud service. 1430 East Bastanchury Road, Fullerton, California 92635 USA. 714-8719590 or 5295521 and 213-6971762. a

BONNIVIER - EXCEPTIONAL HIMALAYANS. SEAL, BLUE, FLAME, Tortie, Blue-Cream Points. Seal, Blue, Flame Point stud service. Bonnie Vierregger, 11664 Pierce St., Omaha, Nebr. 68144 USA. Phone: 402-333-7944 a

ROYAL ROW HIMALAYANS--HOME OF TROUBADOUR OF ROYAL ROW, "Best All Western Himalayan, 1973". Quality kittens and also Choc. & Lilac carriers. Some proven breeders. P.O. Box 128, Bellflower, Ca. 90706 USA. Ph. 213-867-2301. a

HAROBED HIMALAYANS, HOME OF MANY AA, AE AND CFA ALL Star winners. Kittens, adults, stud service. Rose Levy Box 213, Plainview, L.I., N.Y. 11803 USA. Ph. 516-931-0924. b

CAT LORE - HIMALAYANS, PERSIANS, CHOCOLATE/LILAC Longhairs. All Himalayan Point colors and hybrids. Solid/Particolor Persians. Top breeding and show stock. Satisfaction guaranteed. Detailed photos. Laurie Stevens, 1452 N. Latrobe, Chicago, Ill. 60651 USA. 312-622-1030 b

YETI'S CATTERY, REG. CFA, ACFA. HIMALAYANS, BLUES & Seals. Top bloodlines. Kittens and boarding. Dub and Marie Stringfield, P.O.Box 831, Buras, La. 70041. Home raised. a

BADI HIMALAYANS - FOR SALE 2 SEALPT. MALES, 2 CP MALES, 1 black hybrid male. Stud service by reservation, please. Grand Champion & Champion sired. Heidi Noddin, 105 Young Blvd., Universal City, Texas 78148 USA. f

PURRING LANE. OUTSTANDING FLAME AND TORTIE POINTS. Regional winners. Proven, champion stock available. Reservations on show quality kittens. Virginia Lane, 5617 Division St., Lowville, N.Y. 13367 USA (315) 376-3635 d

ENCHANTA HIMALAYANS: KITTENS FROM \$125-\$200. SP'S BY Mingchui Murdock of Badi; CP's and Solid Chocolates by Mingchui Emir of Enchanta. G. Wertheim, 16710 Lillycrest, San Antonio, Texas 78216 USA a

SEEBING IS BELIEVING, SEND FOR PHOTO, CUDDLY, AFFECTIONATE kittens with Persian faces. Seal & Blue points, born August 25th. Glen Trail Cattery, P.O. Box 171, Topanga, Ca. 90290 USA. b

HIMALAYAN KITTENS. LILACPOINT FEMALES, SELF LILAC MALES Siyah Gush (Holland) and Mingchui (England) lines. Write 14481 Camden, Detroit, Michigan 48213 USA a

DALENE'S HIMALAYANS ARE FROM CHOICE BLOODLINES, LOVING-ly home-reared, carefully bred for purrfect temperaments and Persian type. They loved us, now we have some ready to love you. Pet, breeding or show quality in Blue, Seal, Chocolate, Lilac/Frost Points. Proven adults occasionally. Self colors sometimes. Stud service limited to approved queens. Serious inquiries welcomed. Gracie O. McCarty, 511 Ware, San Antonio, Texas 78221 USA. Ph: 512-924-3392. e

RONOMERE HIMALAYANS--KITTENS & PROVEN BREEDERS AVAILABLE. Seal/Tortie/Blue/Bluecream/Flame. Hybrids. Stocky bodies & gentle dispositions. Pedigree sketches on request. P.O.Box 1492, Huntington Beach, Ca. 92646 USA Phone: 714-839-2649. d

Japanese Bobtails

CAER DALBEN. LOVELY, WELL-BALANCED, HARDY BREED. EXCEL-lent companions. Home raised kittens for pets or show. The Grahams, 2704 Mohican Dr., Dover, Ohio 44622 USA d

Korat

KORATS - THAI-CHI - PROVEN THAI ANCESTRY - GRAND CHAMP-ion bloodlines - CFA-KCFA. Scotte Rabold, 1234 Cumber-land Avenue, Dayton, Ohio 45406 USA. 513-278-7142. c

Lavender Foreign SH

TAWNEE/EENWAT: SUPERLATIVE LAVENDERS. EXTREME TYPE, gorgeous color, fantastic dispositions. 16921 NW 20th Ave., Opa Locka, Fl. 33054 USA b

Maine Coon

KTAADN CATTERY FOR MAINE COONS, REAL DOWNEAST PALS. ALL colors. Pet/Show/Breeding. ACA, CFF, CCA, ACFA, CFA. Ph 207-725-7815. E.L. Eastman, RFD2, Brunswick, Maine 04011 USA. d

YANKEE CATS/YANKEE, SPECIALIZING IN MAINE COON. ALL OF our cats shown in 1973 made All American wins! Health guaranteed. 1810 Edgecliff Terrace, Boise, Idaho 83702 d

NORWYNDE MAINE COONS. SHOW/BREEDING/PET. TOP BLOODLINES Bred for disposition/type. Tabbies, parti-colors, sol-ids. Spring/Fall. Ph. 201-694-9248. Lillias Vanderhoff, 21 Jacksonville Rd., Pequannock, N.J. 07440 USA c

LET US TELL YOU ABOUT THESE FASCINATING CATS. WRITE: Maine Coon Breeders And Fanciers Association, Ms. Patricia Morrow, Corresponding Secretary, P.O. Box 68, Tolland, Conn. 06084. c

STASIA'S DREAM MAINE COONS. SHOW/BREEDING/PET. CHAMPION bred. Bred for disposition/type. Whites, Blacks, Tab-bies. Ph. 201-935-3320. 103 Court House Place, Jersey City, N.J. 07306 USA. b

Manx

BRIGADOON CATTERY--MANX ONLY. ACFA AND CFA REGISTERED. Show/breeding/pet stock; Black and Brown Mackerel Tabby Rt.6, Box 109-C, Austin, Tx. 78746 USA. 512-264-1825. a

VENDA MANX. THE MAN'S CAT WOMEN LOVE. TOP SHOW/BREEDERS /pets. Reduced prices to those who will alter. Martha Jones, 410 N. Rapp Road, Talent, Oregon 97540 USA Phone: 503-535-2935 a

INTERNATIONAL COLORPOINT MANX CLUB. HELP DEVELOP OUR breed. Built Manx, patterned Siamese. Big purrs, small voices. Diana Trezise, 1229 100th St. NE, Seattle, Wa. 98007 USA. b

Persian

CATSPURR CREAM PERSIANS. PET PRIDE APPROVED. CFA. GR.CH. stud service. Home-raised kittens--pet/breed/show. 1521 Larkfield Lane, Charlotte, N.C. 28210 USA a

CHINCHILLAS & HIMALAYAN COLOURPOINTS ARE OUR SPECIALTY. Kittens from "Best In Show" Champion queens by Champion studs sometimes for sale to loving homes. Marilyn Woodend, The Nook, Ninebanks, Whitfield Hexham, North-umberland, ENGLAND a

ZELANDO OFFERING AFFECTIONATE, HOUSE-RAISED, ACFA-CFA kittens, breeders, Grand Ch. backgrounds. Top blood-lines. Blues, Smokes, Cameos, Reds. 118 Hilltop Drive, Talent, Or. 97540 USA. 503-535-4115 a

BE-RU SILVERS, PET PRIDE APPROVED. SHOW/BREEDER/PET. Stud service. Lovable kittens from Grand Champion, Champion stock. Top bloodlines. Mrs. Robert Barrett, 944 Paularino, Costa Mesa, Calif. 92626 USA. 714-540-6985 c

DAVIRO: TOP QUALITY KITTENS/ADULTS IN SOLID, SMOKE, Cameo, Cameo Recessives. Finest bloodlines. Fairly priced. Pet Pride Approved. Mrs. David Dieter, Oronoco, Minn. 55960 USA. Tel. 507-367-4705. c

LIN-LEA - KITTENS FROM OCTUPLE GRAND CHAMPION "ZEUS", Sextuple Ch. "John Henry". See ads in Cats/CFA Year-books. Judy Beery, 1944 Atlin, Duarte, Ca. 91010 USA 213-358-5607. c

PERSIANS BY JO-LE. CFA GR.CH. STUD SERVICE. SOLIDS AND Parti-colors. Breeding and show quality. 225 Hampton Rd. Syracuse, New York USA. Ph. 315-474-2138 c

MAGI-PURR KITTENS, CHAMPION SIRE, CFA/ACFA SHADED SIL-ver/Chinchilla, lovingly home-raised. Show curtains, Kitty bibs. Melinda Gregory, 2050 Stevely, Long Beach, Calif. 90815 USA. 213-431-0268 evenings. c

7 OAKS PERSIANS - REDS, RED TABBIES, TORTIES. OTHER colors occasionally. Phone 315-458-0722. 122 Ford Drive, No. Syracuse, N.Y. 13212 USA c

BIRCH HILL--REDUCING CAMEO BREEDERS--RED SMOKES, REDS, Shaded. Solids--Blue male, B.E. and O.E. White kit-tens. Betty Vogt, 177 Apollo Dr., Rochester, N.Y. 14626 USA. f

RUFFHAUS SILVERS. QUALITY COLORBRED KITTENS FROM CASH-mere, Delhi, Silver Dawn, Walnut Hill bloodlines. Pho-tos, pedigree sketches on request. 11A Brookside Ave., Bellport, New York 11713 USA. 516-286-3728 f

SUZANNE PERSIANS - BLACKS AND COLORBRED SILVERS, SOME Blues and CEWS. Black CFA Gr.Ch. Ra-Le Muffin's Shadow of Suzanne (GLR 10th Best Cat) at stud to approved queens. Show kittens usually available. Suzanne Schab-el, 44 Briggs Avenue, Fairport, N.Y. 14450 USA Ph.: 716-377-5334. f

BEAUTIFUL BARWELL PALE CREAM PERSIAN KITTENS. EXCELLENT pedigree, well grown, good type, fabulous coats, deep amber eyes, very affectionate. Only to loving homes. Phyllis Fawell, Broomfield Corner, Broomfield Park, Sunningdale, Ascot, Berkshire, ENGLAND a

MI-DE'S TOP MIDWEST BLOODLINES. BLACKS, REDS, BLUES, Torties, Silvers and Seal Point Himalayans. Kittens available. Excellent disposition. Raised with children and dogs. 206-494-4068 a

DAWN-DEE PERSIANS--QUALITY BLOODLINES. SOLID/PARTICOLOR /Cameo. Grand & Champion proven female available. Mr./Mrs. Jack Miller, 4748 W. Clarendon, Phoenix, Az. 85031 USA. 602-272-1971. b

MINNEWASKA CATTERY--BLUES, BLUE CREAMS, CREAMS, WHITES. Stocky bodies, small ears. Mrs. Roy Vegoe, Glenwood, Mn 56334. Phone: 612-634-3137. b

GOLDAMIST. CFA. ACFA. PET PRIDE APPROVED. BLUES/BLACKS/ Creams/Particolors. Kittens/Stud Service. Mrs. Evelyn Gold, P.O. Box 3445, Cocoa, Fla. 32922. 305-636-0085. Inquiries answered promptly. b

BETSY-BEE PERSIANS FROM CHAROE, K'LANE, BATTOHADI, STO-nybrook and Castilia lines. Kittens and cats. Stud ser-vice to approved queens. Betsy Boyer, 227 N. Yale Ave., Villa Park, Il. 60181 USA. 312-279-8955 b

SILVER WILLOW CATTERY. SPECIALIZING IN CHAMPION-SIRED Silver Tabbies. Available now. Very good eye color. Lucy Kizzier, 9353 Harney St., Omaha, Neb. 68114 USA. 402-393-4086. b

JULIANA CATTERY PRESENTS BEAUTIFUL RED TABBYS. CFA REG. Elco, Smithway blood lines. Cats, kittens, breeding, show types. Anna Koontz, 787 E. Portals, Fresno, Ca. 93710 USA. 209-439-8630. a

KEEPSAKE: CALICOS, BI-COLORS & MOST SOLIDS FROM THE finest Champion bloodlines. Karen Ghyst, 3926 Newmark, San Bernardino, Calif. 92405 USA. Ph. 714-886-8416. a

INTERNATIONALLY KNOWN SONATA PERSIANS FOR SMOKES AND Chinchillas of quality, reared with affection and every care by Mrs. Roden, Greenholme, First Avenue, Stanfor-le-Hope, Essex, ENGLAND a

PERSIANS (CONTD.)

ILLAHE CATTERY. CFA, ACFA PERSIANS. CASHMERE, DEARHEART Groot, Kim-Con bloodlines. Reasonable, wonderful dispositions. Clara E. Nelson, R2, Box 112, Portland, Oregon 97231 USA. d

KAMOLOT--CAMEOS, SMOKES, SOLIDS, PARTICOLORS, CAMEO, Smoke, Tortie, Black, Red Tabby kittens. Stonybrook, Erman, Bloemhill, Lowlands, Azulita bloodlines. Klimack, 211 Peck Rd., Hilton, N.Y. 14468 USA. 716-392-7451. d

HARDENDALE SMOKE, BLACK, PARTI-COLOUR, CAMEO, PERSIANS from "Best In Show" winning stock. Doreen Hoyle, Lane House, Silsden Moor, Keighley, Yorks. England. Tel.: Steeton 53491. d

CH. TIMOR SIR LANCELOT, CREAM, AT STUD. LOVELY PALE Blue proven son, \$200. Blues/Creams/Blue-Creams. Breeder/show. Timmons, 452½ Quince, Salt Lake City, Utah 84103 USA. d

BECAUSE PERSIANS OFFERS TOP BLOODLINE SMOKES, CAMEOS & Solids. Champion-sired breeders and show quality. Reasonably priced. Rita Bee, R.R.3, Rochester, Minn. 55901 USA. d

INTRODUCING WHIS-PURR CATTERY. A NEW NAME FOR QUALITY Silvers. Excellent bloodlines, loving dispositions. Gertrude Goode, 6207 Royal Oak Drive, Orlando, Florida 32809 USA. 305-855-5910. d

IDELIZE KATTERY SPECIALIZING IN BLUE SMOKE PERSIANS, also Black Smoke, Blue Cream, Silver and associated colors. Blue, Seal and Flame Himalayans. Home raised with personality plus! Marlene L. Ide, Little Meadows, Pa. 18830 USA. e

MELITA CATTERY, "HOME OF SWEET PERSIANS". SMOKES, Blacks, Whites, Blues & Silvers. CFA regd. Cats, kittens, stud service. Ethel Miller, 310 Monterey St., Vallejo, Ca. 94590 USA. e

PITNEY FARM HAS BREEDER AND SHOW QUALITY PERSIANS. Bloemhill/Shawnee/Erman bloodlines. Blacks, blues, torties, blue-creams. Joanne Gilbertson, Route 1, Cottage Grove, Wisc. 53527 USA. b

SILVERS, SMOKES, SOME SOLIDS. SHOW/BREEDERS/PETS FROM \$65. Sire, Regional color male. Silver adult male \$115. Others. Countryscheier, Lone Jack, Missouri 64070 USA 816-566-2730. b

Rex - Cornish

ONLY GENE ONE REX BEING BRED BY ZUREIQA CORNISH REX IN country surroundings. Strong healthy kittens available later on. Mrs. Hamilton, Haskers, Westleton, Saxmundham Suffolk, ENGLAND. a

KENI KATZ. KITTENS FROM OUR CFA CHAMPIONS--GRANDS/REGional/National winners available by reservation. Most colors. Pet Pride Approved. Satisfaction guaranteed. Inquiries answered. Ed and Cynthia Dyer, Rt. #1, Black Mountain, North Carolina 28711 USA. 704-669-8355. b

RIAU-ARCH CATTERY. WEST AUSTRALIA'S HOME OF THE CURLIES Self colours and Torties available now. J. & N.F. Bullcock, 11 Regan St., Coolbellup, West Australia 6163. f

BODANTE BLACK REX KITTENS. GRAND CHAMPION SIRE & DAM. Rodell/Anglo-Tex/Som Chai/Annelida. Born April, 1973. 5395 S. Miller, Littleton, Co. 80123 USA. 303-986-0442. f

HEPHZIBAH CORNISH REX. MY SIX LOVELY QUEENS BEAR KITTENS of all colours to Champion Masambula. My other stud, Watermill New Penny, gives me kittens that are a total outcross and enables me to offer breeding pairs of top show/breeding quality. Mrs. Margaret John, Hollyhurst, Chiddingfold, Surrey, England. d

LOHTEYN REX KITTENS FOR SALE. WHITES (BLUE-EYED & ODD-eyed). Also Si-Rex & various solid colours. All have the world famous Lohteyn coat, type & temperament, bred from Champion Lohteyn stock. Only positively top quality kittens exported. Leo Heath, Layters Close, Chalfont St. Peter, Buckinghamshire, England. d

RODELL REX - DRASTIC REDUCTION IN STOCK. SEND FOR COMPLETE list of cats available. Bob & Dell Smith, 255 Fairview Road, Ojai, Calif. 93023 USA. Ph. 805-646-6378

TRILOGY CATTERY - CORNISH REX BRED FOR TYPE, COAT, DISposition. A strong combination of import and domestic lines. Kittens and stud service available. Most colours. Joe and Janet Bielitzki, 904 N. Broadway, Apt. 206, Urbana, Ill. 61801 USA. 217-367-2046. e

Russian Blue

BLUE SANDS - FIRST LITTER SYNEVA-CARMAC LINES OFFERS pet, breeding, show quality kittens. Excellent type and dispositions. 3138 39th Place, Albuquerque, N.M. 87116 USA. 505-268-9756. f

BLUEGENES CATTERY. QUALITY RUSSIAN BLUES FROM EXCELLENT bloodlines. Kittens usually available. CFA-ACFA registered. Judith Kethley, 533 Elgin, Forest Park, Illinois 60130. Phone 312-771-5589. b

SYNEVA CATTERY--RUSSIAN BLUES FROM GRAND CHAMPION BLOOD lines. Stud available. We welcome inquiries. The Kirsch's, 4161 Donald St., Palo Alto, Ca. 94306 USA. 415-948-6365. b

FOR SALE: CH. & R.M. QUAD CH. DAYTIME BLUE MAX. (NEEDS two finals for Grand). 1½ years. Sire: Hy-Line's Blue-Prince. Loving disposition. Superb health and condition. \$250. Candy Craig, 10447-3 Larwin Ave., Chatsworth, Ca. 91311 USA. (213) 341-4461. a

Self - Longhair

PITTMAN'S, KITTENS AND CATS, THE NEWEST LONGHAIR COLORS Deep Chestnut Brown with Orange Eyes and Light Lilac with yellow eyes. Some carry the Himalayan pattern. Truly a lovely cat to own. Elinor Pittman, 1430 East Bastanchury Road, Fullerton, California 92635 USA. 714-8719590 or 5295521 and 213-6971762. a

Siamese

FANCICATS - QUALITY KITTENS/ADULTS. SHOW/BREEDER/PET. Outstanding male Champion for sale. At stud Triple Champion Fancicat's Corcoran. Clare Braun, 406 Fairmount, Philadelphia, Pa. 19123 USA. Also Burmese. a

SAMOW CATTERY - SIAMESE - SPECIALIZING IN LYNX POINTS. Seal, Blue, Chocolate & Frost kittens also available. Lynx & Seal Points at stud. All enquiries answered. Irma Castle, 362 Mapleview Drive, Winnipeg, Manitoba R2P OK3 CANADA. Phone: 204-338-8677. a

SYLBA SIAMESE. STUD CHAMPION ELBARAKA TROPHIMUS. REGD. 32A Red Pt. Sire Champion Siepoo Storm. S.P. Kittens from Champion-sired Queens. Prue Critchley, Park Farm, Barton-Under-Needwood, Staffs. ENGLAND. Phone: 3113. a

MARKYN CATTERY - SPECIALIZING IN FINE LILAC & CHOCOLATE Point Siamese. Stud service to excellent Siamese and Russian Blue males. Kittens and Boarding. Rockland, Massachusetts USA. 617-878-4401. a

DARLING SIAMESE. ALL COLOURS. CHAMPION STOCK KITTENS usually available. Red/Tortie Point specialist. References required. Mrs. I.M. George, 19 Larchfield Street, Darlington, Co. Durham, England. Phone 66630. c

OPHIR - FINE SEALS AND BLUES. BLACK BART, ZAPATA, BLUE Cavalier and Mr. B in one generation. Mary Lou Nolan, 10368 Carrollwood Lane, Tampa, Fl. 33618 USA. 813-935-6321. c

BEV-LEN SIAMESE CATTERY - PET PRIDE APPROVED. CHAMPION bred/sired kittens, Lilac/Choc. Occasionally Blue/Seal points. Mrs. Leonard 'Bev' Reedy, 962 No. McClellan Ave Decatur, Ill. 62522 USA. f

FOR SALE: ADULT BREEDERS--MOSTLY CHAMPIONS--IN LYNX, Albino, Red, Tortie, Lilac, Blue. Also kittens. Lovely Cattery, RD#2, Box 758, Annville, Penna. 17003 USA 717-867-4275. f

AT STUD: TABBY POINT SIAMESE, CHAMPION CHOSEN PHANTOM Fella. Also S.P. Birman Shaminka Houdini, Himalayan Meonvale Morgan. Kittens for sale from time to time include Burmese, Siamese, Birman, Rex & Colour Points. Mrs. Jo Cresswell, Bouladuff, Marine Road, Greystones, Co. Wicklow, IRELAND. a

LEGOULLON'S SIAMESE - ALL COLORS - STUD SERVICE. TOP winning lines, Jen-Kins, Maloja, Jo-San, Tap Toe, Pure English - Makhanda, others. Ann LeGoullon, 19403 Vineyard Lane, Saratoga, Ca. 95070 USA. Ph: 408-257-2456. a

NOTE TO "PERUSE & CHOOSE" ADVERTISERS



There is no charge for name of country in address.

LIN HOW SAN - CATTERY THAT PRODUCED MOST C.F.A. GRANDS last season - offers outstanding show kittens, all colors. Top males at stud. Betty, Lew, Lynne Rabinowitz, 918 Lanett Ave., Far Rockaway, N.Y. 11691 USA. 212-471-6282. e

SANAN NAM SIAMESE: KITTENS, BREEDERS. AT STUD: CH. ALA-mar Parsifal of Sanan Nam (S.P.), son of "Jazz Beau". Roberta T. Gornal, 21 Agate Rd., East Brunswick, N.J. 08816 USA. Ph: 201-249-2187. e

SHERETA. CFA. EXCELLENT CHAMPION BLOODLINES. BLUE/SEAL. Blue Stud. Inquiries answered promptly. Greta Spencer, 132 Oakwood Road, Charleston, W.V. 25314 USA. Phone 304-342-6424 a

ROSTOV'S LYNXPOINTS: AT STUD, ROSTOV'S LITTLE BIG MAN, 1973 Best All-American, Inter-American Chocolate Lynx-point. Top English/American lines. Kittens. Gary Beck, 538 Lakeside So., Seattle, Wa. 98144 USA 206-323-1830 a SHARA - PERSONALITY PLUS TOP GRAND CHAMPION BLOODLINES. Behind Shara are the best of Thaibok, Catana, Singa, Gaidon, Karnak, Maloja. Kapilian, 39 Edi, Plainview, N.Y. USA. 516-WES-3439. b

VINDABONA. CHOCOLATE, LILAC & SEALPOINT KITTENS. SHOW, breeder and pet quality. San-Toi, Catana and import bloodlines. Trudy Hoffman, 1549 W. Indianola, Phoenix, Ariz. 85015 USA. b

BAYARD SIAMESE, WELL-BRED SEAL AND LYNX POINTS occasionally available to recommended homes only. Mrs. K. Strunin, 44 Beaulieu Avenue, Sydenham, London S.E.26 6PP ENGLAND. f

RED & SEAL-TORTIE POINT KITTENS Sired by CFA NW REG. Red CP SH, Bodante Utopian, x imported queens. Also young Red Pt. queen. CFA/ACFA. Red & Lynx Pt. stud service. 5395 S. Miller, Littleton, Co. 80123 USA. f

VON TEJAS SIAMESE IN BLUE AND SEAL. GERMANY'S SHORTHAIR Cattery Prize 1972. International Champions which sleep in bed with you! Suzanne Summerville, 1 Berlin 37, Prinz-Handjery-Strase 62A, Germany. 815-17-54. d

FENWAY: SELECTED BLOODLINES WHICH PRODUCE TYPEY SIAMESE with beauty, stamina and color. Specializing in Lilacs and Blues. Other colors occasionally. Pedigrees on request. Dodds, 16 Ellsmere Ave., Salem, N.H. 03079 USA d

HEALTHY, AFFECTIONATE KITTENS FROM ALL-CHAMPION STOCK. Registerable all associations. Siamese exclusively (18 colors). Redpoints, Sealpoints, Bluepoints, Lynxpoints, Albinos, Tortiepoints, Chocolatepoints, Lilacpoints. Purr-Ti Kit-Ti Cattery, Laingsburg, Mi. 48848 USA. a

Turkish Angora

TURKISH ANGORAS, PURE NATURAL BREED FROM ANKARA ZOO imports. Thornton's Desert Cattery, 2750 S. Jamie Ave., Tucson, Arizona 85706 USA. Phone: (602) 883-3413 a

CFA'S ONLY BREED CLUB DEVOTED EXCLUSIVELY TO TURKISH Angoras. For membership, kitten/stud registrars, breed information: National Turkish Angora Cat Club, Woodbine, Md. 21797 USA. 301-795-1367. b

MEERA TURKISH ANGORAS, PUREBRED KITTENS BY RESERVATION. Stud service to approved queens. Pet Pride Approved. Inquiries welcomed. Joan Kapetanakis, 1 Edwards St., Roslyn Hts., N.Y. 11577 USA c

TURKISH ANGORA KITTENS FROM ALL AMERICAN QNT. CHAMPS. Champs & impts. Lovely disposition and looks. Inquiries welcome. Tai-Phoon Cattery, RD 1, Box 365, Van Etten, NY 14889 USA c

Advertising deadline is
DEC. 7 for next issue

BREEDER ADVERTISING RATES

1/6 PAGE	U.S. \$ 9.00	U.K. £ 3.60	(Note: There is a 10% discount on advertisements which run in 3 issues.)
1/4 "	12.00	4.80	
1/3 "	15.00	6.00	
1/2 "	22.00	8.80	
FULL "	40.00	16.00	

PHOTOS: Black & White photos can be used in advertisements - \$4.00 (£1.60) each. PAYMENT: Minimum of 50% to be sent when placing ad, balance due upon publication. Pay in US or British funds by check or postal order.



YULE TIDE,

1973

**"CAT WORLD" GIFT SUBSCRIPTIONS
MAKE CHRISTMAS SHOPPING EASY.**

We'll send a greeting announcement with the first issue. "CAT WORLD" binders (\$4.50 ea.) are also welcome Christmas gifts.

SUBSCRIPTION RATES

6 ISSUES PER YEAR
PAYABLE IN U.S. DOLLARS OR BRITISH STERLING

\$4.50/£1.60 (\$9.00/£3.80 AIRMAIL)

PLEASE INDICATE ISSUE WITH WHICH ORDER IS TO BEGIN. BACK ISSUES ARE AVAILABLE FROM MARCH/APRIL, 1973 (1st issue) & ORDERS CAN BE BACKDATED. WE WILL FILL THESE AS LONG AS SUPPLY LASTS.

CAT WORLD, 5395 S. MILLER ST., LITTLETON, CO. 80123 USA

1. ARCO BOOK OF CATS
GRACE POND \$4.95
2. CARING FOR YOUR CAT
THATCHER & RICHARDS \$1.95
3. CAT GENETICS
A. C. JUDE \$6.95
4. COMPLETE CAT GUIDE
GRACE POND \$4.98
5. CAT OWNER'S ENCYCLOPEDIA
BRIAN VESEY-FITZGERALD \$6.95
6. CATS--AN INTELLIGENT OWNERS
GUIDE -- HENDERSON & MEAD \$9.75
7. CATS, CATS, CATS, CATS
JOHN R. GILBERT \$3.00
8. COMMON SENSE BOOK OF KITTEN
& CAT CARE - HARRY MILLER \$3.95
9. COMPLETE BOOK OF CAT CARE
LEON F. WHITNEY, DVM \$5.95
10. COMPLETE CAT ENCYCLOPEDIA
GRACE POND \$15.00
11. COMPLETE SIAMESE CAT
MILO G. DENLINGER \$3.95
12. FIFTY YEARS OF PEDIGREE CATS
M. EUSTACE & E. TOWE \$5.95
13. LONGHAIRED CATS
GRACE POND \$5.95
14. NEW CAT BOOK
DORIS BRYANT \$4.50
15. OBSERVER'S BOOK OF CATS
GRACE POND \$2.50
16. PERSIAN CATS & OTHER LH
JEANNE RAMSDALE \$7.95
17. RAISING YOUR CAT
ROSANNE AMBERSON \$5.95
18. ROYAL CAT OF SIAM
MAY EUSTACE \$8.95
19. SHORTHAIRED CATS
HARRIET WOLFGANG \$7.95

BOOKS FOR BREEDERS

c/o 'CAT WORLD'

5395 S. MILLER ST., LITTLETON, CO. 80123

(Please allow several weeks for delivery)

Worldwide Winners

MAY, 1973, CAPE TOWN, SOUTH AFRICA (GCSA) WESTERN PROV. C.C.
Results sent by Mrs. Linda Emery.

LH; Best Adult-J. Burns' Smk m Lionhead King Malcolm; Grand Ch-J. Slaboer's Chin f Cherie Dearheart Jennifer; Grand Pr-C. Potterton's CEW Benvenuto Picasso; Best Kit-M. Boor's Blu f Mickleham Jonquil. SH; Best Cat on Show & Best Sia adult-L. Grassi's ThyP m Chu Chai's Romulus; Grand Ch-M. Simpson's Simani Hsen Zsada, Bn Bur f; Sia Gr.Ch-P. Gardiner's LP f Kinglee's Lilaque Wanda.

JUNE 2, 1973, ST. ALBANS, ENGLAND (GCCF) SIAMESE CAT ASSN.

Results sent by Mrs. Coral Wagstaff

Best Adult, Best Exhibit, Best Male: M/M Hutton's SP SISLINKI TOPSUN; Best Female: Mrs. Brain's ThyP CHEONA MADEA; Best Male Kitten: C. Wagstaff's RP COOMBEHURST HIGHWAYMAN; Best Female Kitten: A. Durrant's SP SIANJO TITIAN.

JUNE 9, 1973, TRURO, ENGLAND (GCCF) CORNISH CAT ASSN.

BEST LH; Adult A. Allon's CP Osiris Tutankhan; Kit M. Morcom's Blu Per Almund Josef; Neu J. Ashman's Lambeer Super Star. BEST BRIT, SH; Adult L. Cousin's Blu Tamar Valley Wisteria; Neu P. Bray's Manana Alexander. BEST FOR, SH; Adult A. Pike's Bn Bur Linlinkye Shoshone; Kit P. Beall's Bn Bur Seangong Sunstar; Neu D. Merry's Bn Bur Nautikal Squire Knott. BEST SIA; Adult M. Weston's SP Chalmi Sia-Loo; Kit R. Pring's LP Lizanne Lilac Dancer; Neu D. Houlden's Setsomer Ajax. SUPREME EXHIBIT Linlinkye Shoshone.

JUNE 20, 1973, LINCOLNSHIRE, ENG. (GCCF) LINGS. CAT CLUB

BEST LH; Adult S. Yates' Tewhit Tara; Kit S. Gould's Mandessa Sugarplum Fairy; Neu E. Wicks' Almund Angus. BEST SH; Adult B. Hudson's Saffronicus Eshun; Kit Mrs. Burgess' Jundivik Trusty Companion; Neu S. Bull's Peerless Snowman. BEST SIA; Adult H. Stephenson's Ramonda Sandpiper; Kit S. Peters' Kirash Tam-sin; Neu H. Stephenson's Ramonda Ambassador.

JULY 14, 1973, ESSEX, ENGLAND (GCCF) ESSEX CAT CLUB

BEST LH; E. Fisher's Bir Praha Nepseni; Kit J. Nicholls' Smk Per Mizpah Bacchus; Neu M. Kalis' Mystral Sir Echoe. BEST SH; M. Warde's Bn Thy Sherada Nutbrown Maid; Kit M. Warde's Spotted Sherada Silver Felicitas; Neu J. Dell's Bur Kupro Cream Cosmos. BEST SIA; S. Smith's LP Whiterose Zelda; Kit L. Strunin's ThyP Bayard Akhenaten; Neu Mr. Bissenden's BP Sad Blue Rameses. SUPREME WINNER: Sherada Nutbrown Maid.

JULY 15, 1973, SAN FRANCISCO, CA. (CFA) BAY AREA BURMESE BR.

Marked catalog sent by Mrs. Frank Smith

SH; JOHN DAWE'S BEST CAT #126 R/R ROGERS' LP SIA M SANTANA'S PODGORYN; 2BC K/J Seeland's Bur m Prince Tora-Chan Aka Biggie; 3BC T/R Bernstein's CEW Manx m Bo-Lin Augustus John; 4

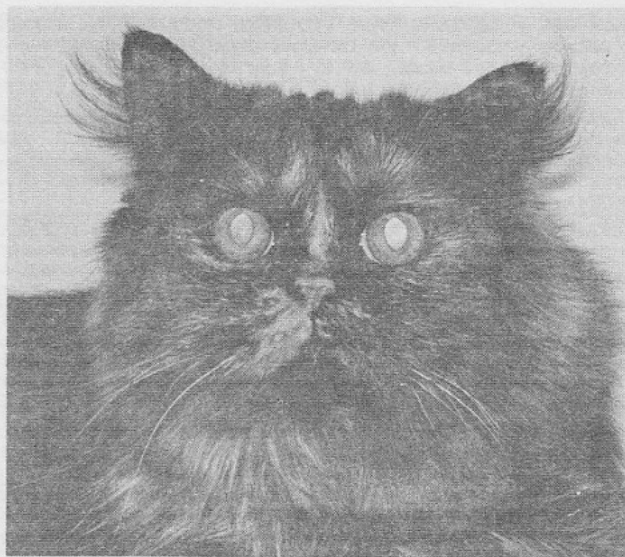

GRAND & DOUBLE GR. CH. BLUE VALLEY MESS, 4-year-old Tortoiseshell Persian owned by Amon Bailey, Texas, was Lynn Cassidy's BEST CAT at the TAM show, Memphis in Sept. She was chosen BEST CAT by Martha Hamilton Rick Hamilton and Ed McNutt at the MAGNOLIA STATE CAT CLUB's March show, and was 1969-70 Crown Cat.

BC T Charley's Bur m Char-Li's Pagan; 5BC #119 D Mare's SP Sia f Sin-Chiang Kali of Mar-Ray; BK #17 C Underwood's Bur m Char-Li's Cupid Capurr; BCP N/J Buell's Bur n Too-Kee's Khy of Burma Matagot. SH; KIM EVERETT'S BEST CAT #126; 2BC #119 3BC #78 C Mozley's Bur f Sim-Sam's Magic Moment; 4BC #74 Hague/Richardson's Bur m Jai Singh Wu of Mocha Gold; 5BC #99 J Noblin's Tor Manx f Briar-Brae Mujercity of Tawilli; BK L/S English's Rdy Aby m Eriador's Flanagan; BCP #146 R/S Siegert's Bur s Christcrest Duchess. SH; PAUL RAINE'S BEST CAT #126; 2BC #99; 3BC L/J Smith's Sh Sil ASH m Arca's California Boy; 4BC L/S English's Rdy Aby m Eriador's Pippin II; 5BC #74 BK F McLaughlin's Bur m Mcl's Brandy; BCP #146. SH EX, BUR; R. HENKE'S BEST CAT #99; 2BC #126; 3BC J/S Turner's LP m Jo-San's Linos; 4BC T Pericola's Tor CP SH Ton Jo's Ember Meeko; 5BC E/S Ironside's Sh Sil ASH m Arca's Chapala of Ironside; BK B/A Coito's CP Sia m Pahala's Thor; BCP T Tucker's ST ASH s Le Sabre Silver Charm of Shawnee. BURMESE SP; RAY HENKE'S BEST CAT #78; 2BC R Jackson's m Desvedado's Ozimandias; 3BC C Cummings' f Burma-Dean's Abilene of Cha-Ming; BK #17; BCP #146.

JULY 28-29, 1973, WICHITA, KS. (CFA) WICHITA CAT FANCY

Marked catalog sent by Janet Rogers.

AB; ADAM FRECOWSKI'S BEST CAT #151 G/N POOLE'S RDY ABY M GALLANTREE'S HOT PANTS; 2BC #189 J Batchelor's Bur m Tok-Lat Little Awful Arnie; 3BC #253 C Rogers' SP Sia m New Moon Eclipse of Rogers Hts; 4BC D Mare's SP Sia f Sin-Chiang Kali of Mar-Ray; 5BC C/M Reich's Bur f Mar-Chu Piccadilly; BK #8 D Cook's Cm Per f Jadon Karmel Sundae; BCP #299 H Boyer's Blk Per N Rojan's Dark Shadow of Duncan. AB; DON YODER'S BEST CAT #121 E/J SANDEFUR'S CM PER F WILLOW GLEN CHECKMATE; 2BC Maddox/Griffey's Bur m Senshu's Roadblock of Nomad; 3BC R/J Bauer's Aby m Gallantree's Hobbie Cat; 4BC W Gamblins' Tor f Per Wynden's Skylark of Silouetta; 5BC #189; BK #8; BCP #306 A Bourke's Bur n Pussy-Pur-Mew Raeben. LH; VIRGINIA WOLFE'S BEST CAT J JARRETT'S BLU PER F WIKIUP INDIAN BUTTONS; 2BC #121; 3BC #102 J Jarrett's Blk Per m Wikiup Montezuma; 4BC K Duncan's Bn Thy Per m Silver Willows Don Roi of Duncan; 5BC #108 M Thompson's Blk Per f Duncan's Dubonnet; BK #8; BCP #299. SH; VIRGINIA WOLFE'S BEST CAT #151; 2BC #189; 3BC #253 4BC R Christ's Rdy Aby f El Qahira's Deseret; 5BC E Davis' SP Sia f T-Uyo Zia of Thaiok; BK C Palladys' Rdy Aby m Pal-lady's Native Dancer; BCP B Salzman's CP Sia n Nor-Bob's Cho chu of Catagory. LH; BARBARA MAIER'S BEST CAT #102; 2BC #121; 3BC #108; 4BC Gamblins' Skylark; 5BC N Davis' Rd Per m Willow Glen's Hannibal Hayes; BK #8; BCP #299. SH; BARBARA MAIER'S BEST CAT #253; 2BC L Schweitzer's Rdy Aby m Purr-Ong's Bir-Han; 3BC D Lucek's Bur f Tok-Lat's T.N.T. of Cima-rron; 4BC Thompsons' RB m Velva's Gone Blue of Les Joy; 5BC Quader/Litts' ST ASH f Kevron's Merry Gretl; BK J/J Utsey's BP Sia f Lineage Mist; BCP #306.

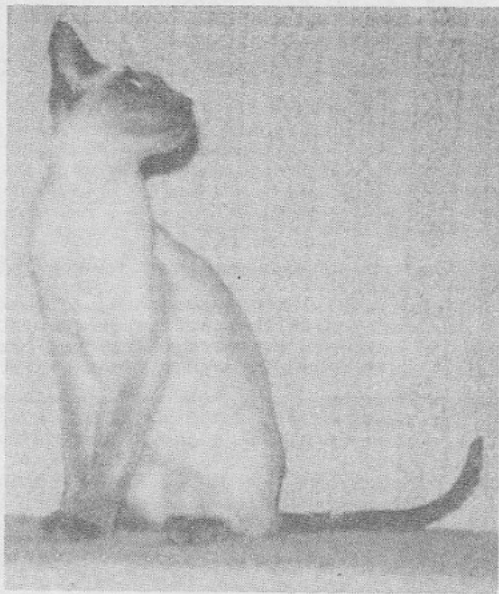

Judge Barbara Maier's BEST SHORTHAIR KITTEN at the WICHITA CAT FANCY's July show was Jonieta and Jordan Utsey's Blue Pt. Siamese female, LINEAGE MIST, born Jan. 18, 1973.

moving?

PLEASE SEND YOUR NEW ADDRESS TO "CAT WORLD"
BEFORE YOU MOVE. DON'T MISS YOUR COPY.

SEPT. 1, 1973, PALO ALTO, CALIF. (CFA) AMERICAN SH WEST

Marked catalog sent by Mrs. Frank Smith. All Shorthairs.
 JANE MARTINKE'S BEST CAT #91 R/C NACE'S BLK EX SH M KALAMARS
 KAHULA; 2BC #118 R/R Rogers' LP Sia m Santana's Podgorny;
 3BC M Quire's BP Sia f Thai Bok Titania of Quire's Gal-X-C;
 4BC R Kuhnel's BnMkTby ASH m De Tracy's Gas Man of Gato Rey
 5BC J/S Koval's Sh Sil ASH m Arca's El Bravo of Cachet; BK
 D King's Blu ASH f Chateau-Du-Roi Grisette; BCP #131 Barbar-
 ino's Wh Manx s Love Bunny's Snow Flurry. VIRGINIA WOLFE'S
 BEST CAT #91; 2BC C/C Hummer's SP Sia f Cath-Son's Alicia;
 3BC #115 D Mare's SP Sia f Sin-Chiang Kali of Mar-Ray; 4BC
 #118; 5BC #73 Tucker/Stockett/Moen's Rd MkTby ASH m De Tra-
 cy's Curious George; BK #46 R Manchee's CP Sia f Serendipity
 Sock It To Me; BCP S Anderson's Sh Sil ASH n Arca's Takaro.
 PAUL RAINE'S BEST CAT #118; 2BC W Palmer's RB m Hy-Line's
 Silver Cloud; 3BC #115; 4BC J Tucker's Bn Tby ASH m De Tra-
 cy's Chipmunk; 5BC F/B Smith's Bur m Wylie C of Bowbell; BK
 #46; BCP K Hummer's BP Sia n Cath-son's K.J.'s Loki. DONNA
 DAVIS' BEST CAT W PALMER'S RB M HY-LINE'S BLU-PRINCE; 2BC #
 118; 3BC #73; 4BC W Palmer's RB m Hy-Line's Blu-Note; 5BC #
 115; BK #46; BCP #131.

SEPT. 1-2, 1973, MEMPHIS, TN. (CROWN) T.A.M.

Marked catalog sent by Mrs. Mary Bolles.
 AB: LYNN CASSIDY'S BEST CAT #71 A BAILEY'S TOR PERS F BLUE
 VALLEY MESS; 2BC #108 W Kaiser's Blk Sphynx f Dutchie's Nef-
 ertiti of Mewi'kal; 3BC #83 J Graham's Rdy Aby f Quin-Jo
 Irish of Cohana; 4BC #73 H Dowda's RP Him m Holli-Hi Red
 Alert of Mao-Jen; 5BC G/M Brown's SP Sia f Thai-Am's Saronia;
 BK #4 H Dowda's Rd Tby Per f Mao-Jen's Marmalade; BA I Ryans'
 RdMkTby Per N Bemydot Oh No Andrew. AB: ROBERT ZENDA'S BEST
 CAT #108; 2BC #52 M Jennings' Rd Per m Bemydot Bolihi; 3BC #
 95 M Bolles Sh Sil ASH m Si-Aby's Mr Shad; 4BC #73; 5BC #71;
 BK #14 B Wright's CP Sia m Irish Hill's Shannon; BA #123 R
 Lehmenkuler's Blu Per n Ceefall's Blue Colonel. AB: RON
 MURPHY'S BEST CAT #55 W STEPHENS' SH CAM PER M CATSREALM
 CURACAO OF CYNDI-KITS; 2BC #52; 3BC #71; 4BC M Bolles' Rdy
 Aby f Si-Aby's Tiy Tiy; 5BC A Costa's BP Sia m C.J.'s Lord
 Samson; BK #4; BA #123. PAT SMITH'S BEST LH CAT WURZBURG/
 NEWTON'S CEW PER M SIMBELAIR JACQUES OF SHOW'N TELL; 2BC #73
 3BC #71; 4BC P Bowers' Sh Cam m Cindi-Kits Pasha of Green-
 vrier; 5BC #52; BK #4; BA #125 M Jennings' Sh Cam Per n Bemy
 dot Specialty of Our House. PAT SMITH'S BEST SH CAT #108;
 2BC D Wrenn's Rd Tby Rex m Nike Huey; 3BC M Bolles' Sh Sil
 ASH m Sandef's John Adams; 4BC M Peirce's Egy Mau Hell Gates
 Gwalior; 5BC #96 M Bolles' Sh Sil ASH f Si-Aby's Snow; BK #
 14; BA C Harbison's Rdy Aby n Si-Aby's Brandy. PAT ANDER-
 SON'S BEST LH CAT W STEPHENS RD TBY PER F CATSREALM REBECA
 OF CYNDI-KITS; 2BC #52; 3BC #55; 4BC #71; 5BC W Stephens' Sh
 Cam Per f Cyndi-Kits Ginger Snap; BK M Ebbing's Tor Per f
 Corojoh's Sunflower of Ebb'Tide; BA #125. PAT ANDERSON'S
 BEST SH CAT #83; 2BC #96; 3BC #95; 4BC Browns' Saronia; 5BC C
 Colton's RB f Bethsheba of Kozy Kitten; BK G Clower's BP Sia
 m Hi-Land Hts Jason; BA C Segerson's HB n Namekagon Eager
 Beaver.

SEPT. 15-16, 1973, MANITOBA, CANADA (ACFA) MANITOBA CAT CLUB

Marked catalog sent by Mrs. Lois Varey.
 AB: BETTY HARALAMPUS' BEST CAT #120 J STEVENS BLU PER F KIT-
 WILLOWS SCRUMPTIOUS; 2BC #166 L Varey's BC BSH f Broadweir
 Stardust of Kalico (Imp); 3BC #197 M Warnock's FP Sia f Jo-
 Jo's Lone Star; 4BC #209 B Williams' SP Sia m Sanuk's Night
 Flight of Clivedene; 5BC R Carlson's Blk Per m Mon Serein
 Napoleon; BK #11 J Oberto's Per-Ette No-No Nanette BC Per f;
 BA N Newman's Blu Per n Mon Serein's Sir Misty Twilight. LH:
 EDWARD BREHM'S BEST CAT #120; 2BC M Wold's Blu Per m Minne-
 waska's Lil Beaver of Iwilei; 3BC #127 L Jakobson's Cm Per m
 Minnewaska's Hubert of Ram Ree; 4BC #131 R Vegoe's BC Per f
 Minnewaska's Tonja; 5BC #128 D Klarner's Rd Tby Per m Daisy-
 field Apple Jack; BK #11; BA H Christensen's Sh Sil Per s
 Andoria's Tascha. SH: EDWARD BREHM'S BEST CAT #166; 2BC 197
 3BC #209; 4BC B Bremer's ST ASH f Litter Inn Bathsheba; 5BC
 #174 J Bodner's Bur m Waterford's Rocket of Lo-Bod; BK #25 J
 Jeffrey's RB f Hy-Line's Holly of Rio Vista; BA #262 G.Thomp-
 son's BP Sia n Jo-Jo's Tango D'Orr. AB: JOAN APEL'S BEST
 CAT #128; 2BC M D'Avignon's Bur f Petula of Nee-Ja; 3BC #166
 4BC #174; 5BC #197; BK H Voelker's BC&W PC Mx f Seolfor Hyll
 Tara; BA E Vaala's Ch Sil Per s Silver Dollar Secret of Mon
 Serein. LH: GLORIA STEPHENS' BEST CAT #127; 2BC #121; 3BC #
 120; 4BC #128; 5BC #131; BK H Christensen's Bn Tby Per m An-
 doria's Mr. McTavish; BA M Winters' Red Per s Kitwillows
 Merry Sherry of Jasmin. SH: GLORIA STEPHENS' BEST CAT #209;
 2BC #174; 3BC K Hainer's Bur m Brierwood's Tin Angel of Wat-
 erford; 4BC M Warnock's RP Sia f Jo-Jo's Ruby Ann; 5BC M
 Warnock's FP Sia m Jo-Jo's Whizz Bang; BK #25; BA #262. AB:
 MAXINE POTTER'S BEST CAT #166; 2BC #121; 3BC #120; 4BC #128;
 5BC #209; BK #25; BA #262.



COOMBEHURST HIGHWAYMAN, Red Point Siamese
 owned by Mrs. Coral Wagstaff, was BEST MALE
 KITTEN at the Siamese Cat Assn. show in June
 at St. Albans, England. Now 11 months old, he
 has won 2 C.C.'s and 5 Best-In-Show nomina-
 tions. He was born en route to a show!

SEPT. 15-16, 1973, SCHENECTADY, NY (CFF) MOHAWK VALLEY C.F.

Marked catalog sent by Beverly E. Jones.
 AB: JAMES WALLING'S BEST CAT #199 J MAYER'S ST ASH M GO-SEEK-
 US IKE; 2BC D Worrell's OEW Per m Maison de Chat's Lil Drum-
 mer Boy; 3BC #202 G Thornton's CEW Rx f Byken Dee's Bon Bon;
 4BC N Van DeGiesen's LP Sia f Velvet Paws Natasha San Rei;
 5BC L Posey's BP Sia m C.J.'s Stetan; BK #37 J Hoyt's ST ASH
 f Makwae's Weetamo of Tomoka-Oaks; BA #69 W Ives' Rdy Aby
 Suma of Charmayne. AB: DORRIS HOOK'S BEST CAT D WORRELL'S
 CEW PER M SIMBELAIR JET OF MAISON DE CHAT; 2BC #199; 3BC 202
 4BC #155 A Morace's Bn Tby m Per Mor-Ace's Satan; 5BC #131 D
 MacDonald's Blu Cm Per f Macdot's Heather; BK #17 J Waitt's
 Tor Per f Kalamar's Dinal of Janeway; BA N Abrams' ST ASH s
 Lynn-Lee's Twinkle of Akatoru. LH: PAUL THIELEN'S BEST CAT
 #87 L Samuels' CEW Per f Window Powder Puff of Q-T Cats;
 2BC #85 A Arvin's CEW Per f Darwin's Doll Face; 3BC #131;
 4BC R Bush's Sh Sil Per f Bauman Lady Lyne-Elle of Ray-Ann;
 5BC I Roberts' Cm Per m Shawnee Tammy of Willow Lane; BK 17
 BA P Renninger's Cm Per n Tawny Autumn of T.Penn. SH: PAUL
 THIELEN'S BEST CAT #199; 2BC #202; 3BC C Adams' LP Sia f Kit
 Katz's Gabrielle of C.J.; 4BC #163 H Rohrer's LP Sia f Rem-
 bar's Stacey of China-Bleu; 5BC W Ives' Bur f Charmayne's
 Chicadee; BK #37; BA J Kryszczuk's BP Sia n Far East Ben
 Blue. LH: PHILLIP ALBERT'S BEST CAT P HANCOCK'S CM PER F K-C
 TOKEN OF TUSEY; 2BC #155; 3BC #87; 4BC #85; 5BC P Rennings
 Blu Pt Him f Marlos Tiffany T.Renn; BK C Schaefer's Cm Per m
 La Petite's Sunny Boy; BA P Renninger's Sh Sil Per s Confec-
 tion's Tricia of T.Renn. SH: PHILLIP ALBERT'S BEST CAT #199
 2BC G Thornton's Blk Rex m Byken Dee's Oliver Twist; 3BC L
 Scott's SP Sia f Bonnie Brae Victoria; 4BC K Welch's BnMkTby
 Mx m Warpaint of Mini-Manx; 5BC #163; BK M Keighley's RP CP
 SH m Wee Skelf Tiddler; BA #69.

SEPT. 29-30, 1973, MONTREAL, CANADA (CFA) EXPO CITY CAT CLUB

Marked catalog sent by Chris Keenan.
 AB: RICHARD GEBHARDT'S BEST CAT #145 P/V MARKSTEIN'S BP SIA
 M FELITAN FRODO OF PETMARK; 2BC #52 S Weston's OEW Per m
 Simbelair Azaraf; 3BC #114 Salamone/Brenner's Chin Per f Wal-
 nut Hill Flute of Wyldewood; 4BC #92 M Massie's Blu Cr Per f
 Purring Lane's Widget of Nassau's Dona; 5BC #97 S Weston's
 Blu Cr Per f Simbelair Meisha; BK #22 K Griffin's BP Him m
 Gem's Oski-Wa-Wa; BCP #190 C Shulman's Rd Per s Kitturah's
 Michelle of Pereshte. AB: ADAM FRECOWSKI'S BEST CAT #52;
 2BC #169H Kemp's Bur m KemLen Keowe; 3BC #57 F Trubits' Blu
 Per m Wheeler's Chip of K'Jari; 4BC #145; 5BC #114 J Carvills
 Blu Cr Him f Beach Haven Pastel; BK #22; BCP #190. AB: BEN
 EHRHARDT'S BEST CAT #169; 2BC S Weston's CEW Per f Simbelair
 Muet; 3BC #145; 4BC #114; 5BC #92; BK #22; BCP S Graziani's
 SH Sil Per s Jubilee's Silhouette. LH: EDNA FIELD'S BEST
 CAT #52; 2BC #57; 3BC #77; 4BC #97; 5BC #114; BK #22; BCP #
 190. SH: EDNA FIELD'S BEST CAT #169; 2BC #145; 3BC D Youngs
 Rdy Aby f Crescent Dantara of Amadear; 4BC A Hedberg's BP
 Sia f Petmark's Undine of Sand n'Sea; 5BC J McDonald's BP
 Sia m Tien-Ming Seventh Son; BK Rock/Buckner's SP Sia f Map-
 le Leaf Tara of Queen's Canada; BCP L Crast's Bur n Surdanas
 Tabu.

WORLDWIDE SHOWGUIDE

DATE	PLACE	ASSN	CLUB	JUDGES	INFORMATION CONTACT
PLEASE REFER TO LAST ISSUE FOR ADDITIONAL SHOWS SCHEDULED FOR NOVEMBER					
NOVEMBER					
24-25	Cranston Rhode Is.	CFA	All Breed Cat Club of the N.E.	W.Thompson, Cruz, O'Hara, Slodden W.Beck	M.L.Newton, 35 Sun Valley Dr. Cumberland, R.I. 02864
DECEMBER					
1	London England	GCCF	National Cat Club		Mrs.G.Pond, Barbeches, Buch- an Hill, Crawley, Sussex, Eng.
	Western Australia	RASCC	Osborne Park Agricultural Soc.		Mrs.B.Smith, 15 Axford St. Como, Wa.
1-2	Redwood City California	CFA	Highlanders Cat Club	Eisenman, Rogers, J.Kilborn, Hummer	Mrs.B.Fix, 101 Highland Ave. San Carlos, Ca. 94070
	Columbus Ohio	CFA	Ohio State Persian Club	Hall, Needles, Erhardt, Teron	J.Bolin, 66 Thomas Ave. Grove City, Ohio 43123
	Racine Wisconsin	CFA	United Persian Society (LH)	Caillouet, O'Brien, Wells, Barnaby	H.L. Madison, 828 Oakton, Evanston, Il. 60202
	Alberton New York	CFA	Long Island Cat Club	Koepf, Frecowski, Goodwin, Hutzler, D.Williams	Mrs.J.Kapetanakis, 1 Edwards, Roslyn Hts. N.Y. 11577
	Toulouse France	FIFE	Fedn. Feline Francaise		Mme.M.Ravel, 247 rue de Vaug- irard, Paris XV, France
	Stockholm Sweden	FIFE	SVERAK		Mme.A.Lundegaard, Berghäll Kinnaström, 511 00 Kinna, Swe.
2	San Antonio Texas	CFA	Bluebonnet-Bexar Cats Sp. Clubs	McPhee, Smith	G.Wertheim, 16710 Lilly Crest San Antonio, Tx. 78216
8-9	St.Peters- burg, Fla.	ACFA	Suncoast Cat Club	Pascal, Belk, Stephens, Bremer	F.Happley, 2751 29th St.N. St.Petersburg, Fl. 33713
	Fort Hood Texas	ACFA	Cougar Country Cat Club	Spencer, Nottingham, Morgan,	C.Jonson, 701 Morris Drive Copperas Cove, Tx. 76522
	Lancaster California	CFA	A.V. Hi-Desert Cat Club	Everett, Hiraoka, Evans, W. Thompson	S.Fraser, 41129 18th St.W Palmdale, Ca.
9	Rochester New York	CFA	Iroquois LH Cat Club	D.Williams, O'Hara, B.Smith, Swenson	S.Schabel, 44 Briggs Ave. Fairport, N.Y. 14450
15	Australia Blackpool England	GCCFAV GCCF	Combined Clubs Preston Cat Club	Grand National Championship Show	F.Wolstenholme, Mill Lane, Elswick, Nr. Preston, Lancs.
JANUARY					
5	Ellesmore England	GCCF	Cheshire Area Cat Club		Mrs.K.Benn, Knutsford Old Rd. Stockton Heath, Warrington
5-6	Canton Ohio	CFA	Canton Hall of Fame Cat Club	Needles, B.Smith, Parker, Barnaby	D.Studt, 2533 Grove N.E. N.Canton, Ohio 44721
	Phoenix Arizona	CFA	Copperstate Cat Fanciers	McPhee, D.Williams, Ehrhardt, K.Everett	A.Knowlton, 9040 S.17th Pl. Phoenix, Az. 85001
	Hillerod Denmark	FIFE	Felis Danica		Mme.L.W.Casselgreen, Dyrekaer Tvingstrup, DK-8700 Horsens.
12-13	Houston Texas	CFA	Houston Cat Club	Gebhardt, K.Everett, Weiss, Eisenman, Rotter	Mrs.T.Griffey, 14435 Chad- bourne, Houston, Tx. 77024
	Pasadena California	CFA	Hollywood-Hacienda Cat Clubs	Baker, Napolski, M.Williams, R.Everett, McClean, Dawe	J.Billings, 950 Rutland Av. Los Angeles, Ca. 90042
	Ft.Lauder- dale, Fl.	CFA	Confederate States Cat Club	Willwerth, Otto, D.Thompson, Maier, Wolfe	R.Horenstein, 2136B N.E.162 St N.Miami Beach, Fl. 33162
19-20	Brussels Belgium	FIFE	C.C.B.		Mme.C.Rossi, 33 rue Duquesnoy 1000 Bruxelles, Belgium
	Richmond Virginia	CFA	Old Dominion Cat Club	Ehrhardt, Pedulla, Koepf, Fre- cowski, Bebout, Cruz	S.Phelps, 5308 Wingfield, Mechanicsville, Va. 23111
	Tacoma Wash.	CFA	Daffodil Valley Cat Fanciers	Barnaby, R.Smith, Summerville, TBA	S.Lantz, 901 N.Yakima, Tacoma Wa. 98403
19	Norwich England	GCCF	Suffolk & Norfolk Cat Club		Mrs.P.Copple, 16 Columbia Cl. Kesgrave, Ipswich, Suffolk
26	Reading England	GCCF	Siamese Cat Soc. of British Empire		K.Stanley, Welbeck, Oakside Way, Shinfield, Berks.
26-27	Wooster Ohio	CFA	Johnny Appleseed Feline Fanciers	R.Smith, D.Williams, Field, Caillouet	Mrs.R.Jones, 1131 Quinby Av. Wooster, Oh. 44691
	Victoria BC, Canada	ACFA	Island Cat Fan- ciers Society	Denny, Nottingham, Fountain, deHay	D.Wright, 1439 Mitchell St. Victoria, B.C.
	Orlando Florida	ACFA	Action Center Cat Club	Belk, Mozeley, Hubbard, Spencer	R.Horenstein, 2136B N.E.162St N. Miami Beach, Fl. 33162
	San Diego California	CFA	San Diego Cat Fanciers Assn.	O'Brien, Koepf, Hummer, Teron	S.Haynesworth, 1856 Crandall San Diego, Ca. 92111
	Uppsala Sweden	FIFE	SVERAK		Mme.A.Lundegaard, Berghäll Kinnaström, 511 00 Kinna, Swe.



CAT CLUBS:

PLEASE SEND IN INFORMATION ABOUT YOUR NEXT SHOW. Free "CAT WORLD" exhibitors badges, imprinted with Club name, should be requested 3 months ahead of show. These are available to Clubs anywhere in the world as long as the supply lasts.

ACA - American Cat Assn.; ACFA - American Cat Fanciers Assn.; CCA - Canadian Cat Assn.; CFA - Cat Fanciers Assn.; CFF - Cat Fanciers Fedn.; GCCF - Governing Council of the Cat Fancy; GCSA - Governing Council of S. Africa; FIFE - Fedn. Internationale Féline d'Europe; ICFCE - Independant Cat Fanciers of the Continent of Europe; NZCF - New Zealand Cat Fancy; RASCC - Royal Agricultural Society Cat Club.

ANGLO-TEX

ACFA

CFA

Season's Greetings

WE WISH TO ALL OUR FRIENDS THE HAPPIEST OF HOLIDAYS

*Dick, Marion
Kids & cats*

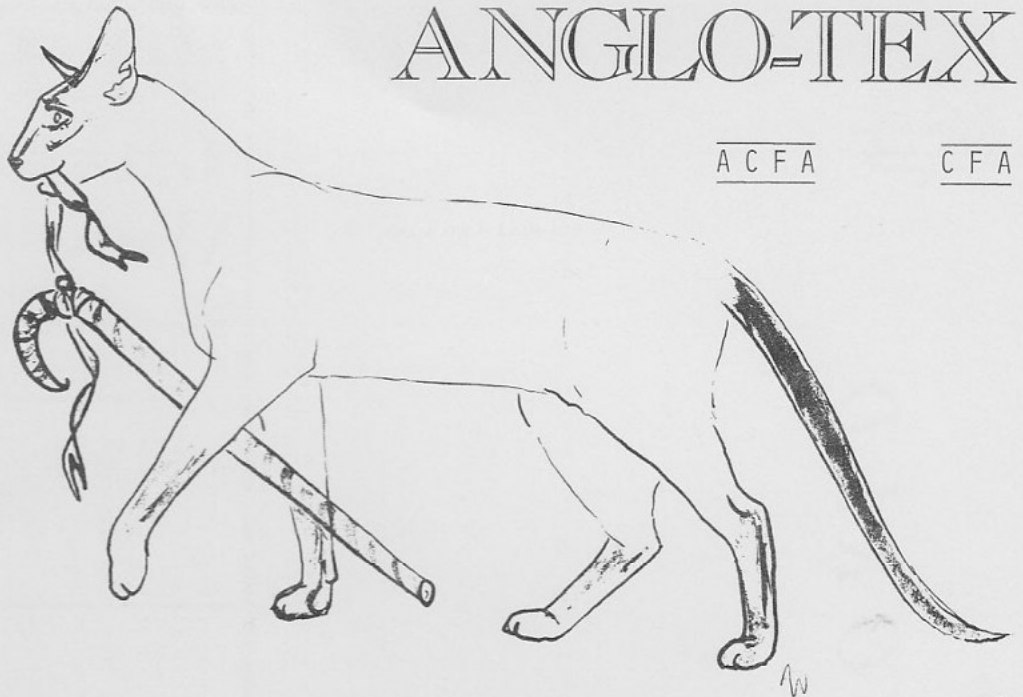

COMMENTS FROM CATS' MAGAZINE:

"THE R.A.E. WHITES ARE OWNERS OF THE MOST WINNERS, SEVEN."
(1971 All Sectionals, August, 1971, page 7);

"ONCE AGAIN THE R.A.E. WHITES LEAD IN NUMBER OF WINNERS--SEVEN."
(1972 All Sectionals, August, 1972, page 9);

"IN THE PREFIX BREEDING DEPARTMENT--INDICATED THE BREEDING OF THE CATS--'ANGLO-TEX' IS FIRST WITH ELEVEN."
(1973 All Sectionals, August, 1973, page 9).

TOP SHOW & BREEDER KITTENS FOR SALE

GENE 1: CORNISH REX

MALES AND FEMALES

GENE 2: DEVON REX

BROWN MACKEREL TABBY MALES

SIAMESE

SEAL POINT MALES AND FEMALES

BRITISH SHORTHAIRES

TWO BLUE MALES

STUD SERVICE FOR THE ABOVE BREEDS TO APPROVED QUEENS

ALL ANGLO-TEX LINES INCLUDE TOP AMERICAN AND ENGLISH IMPORTS. SPECIAL ARRANGEMENTS FOR THOSE INTERESTED IN WORKING WITH AND SHOWING DEVON REX.

R.A.E. WHITE & FAMILY, 4909 TOMAHAWK, AUSTIN, TX 78745 USA

512/444-7346



BULK RATE
U.S. POSTAGE
PAID
Littleton, Co.
Permit No. 233

CAT
WORLD

RETURN POSTAGE GUARANTEED

NO RUZ
cattery

ELAINE GESEL
5334 GENESEE ST.
BOWMANVILLE
N.Y. 14026
Ph. 716-683-5612

Maine Coon Kittens

CHAMPION SIRE & DAM
PUREBRED, CFA-REGD. BLACK BEAUTIES
READY NOW INQUIRIES INVITED.

Turkish
Angoras

BREEDING FOR BEAUTY
AND DISPOSITION

TAI-PHOON KAYA-ALA
OF NO-RUZ (right)
& "SEN" (p.11, Sept.
/Oct. CW) are now
CFA CHAMPIONS.

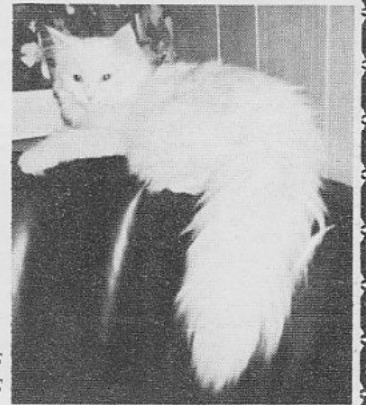

SWEET LOVING KITTENS
WITH LONG SILKY COATS
..... WHY NOT RESERVE
YOURS NOW?

CFA * CCA * CFF

Brock' Ann

SPECIALIZING IN LILAC & BLUE SIAMESE

KITTENS NOW FOR SALE - REASONABLE
(ALL INQUIRIES ANSWERED)

Dam: SI-CATS FAITH,
Lilac Pt. (Gr.Ch. &
Ch. Merry-Mews Astro
Boy, LP, x Gr.Ch. & RM
Gr.Ch. Si-Cats Dres-
den Doll, LP)

CONGRATULATIONS TO:
BROCK'ANN'S ROSEBUD
OF MARALYNN
Hon. Men. Blue Point
Southern Region
RUSTY POOH BEAR
OF BROCK'ANN
3rd Best H.H.P. &
Best SH H.H.P.
in the Nation &
Best SH H.H.P.
in Southern Region,
Happy Household Pet
Cat Club.

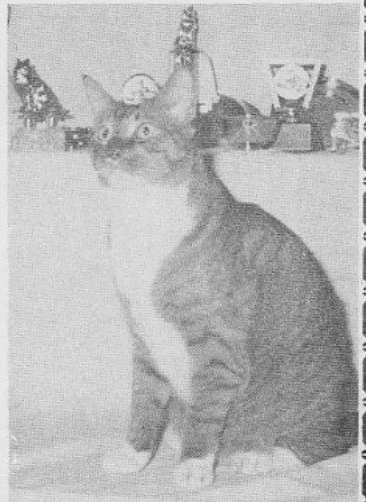

ANN M. BROCKLEBANK
3536 EVERGLADES RD.
LAKE PARK, FL. 33403
Phone: (305) 622-1534

Pet Pride Approved
ACFA/CFA/SCSA
- Stud Service -

FUN
for your
CATS, PUPS
and YOU

PET
TRAPEZE

For PLAY and
EXERCISE with
CORK BALLS

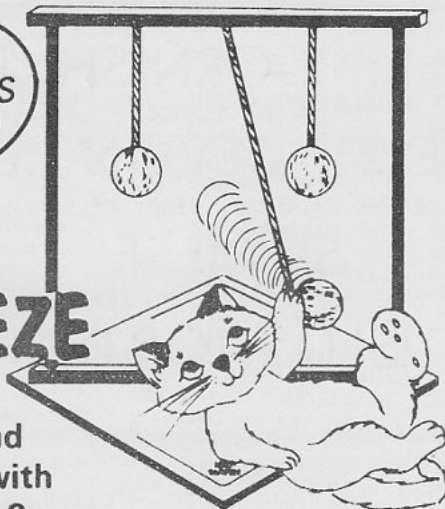

IF NOT AT YOUR LOCAL
DEALER, MAIL \$5.00
FOR POSTPAID SHIPMENT.

\$4.98

Art Craft Enterprises
Tura Bldg, Great Neck, NY 11022